

WYBOT

Robotic Pool Cleaner User Manual

WYBOT C1

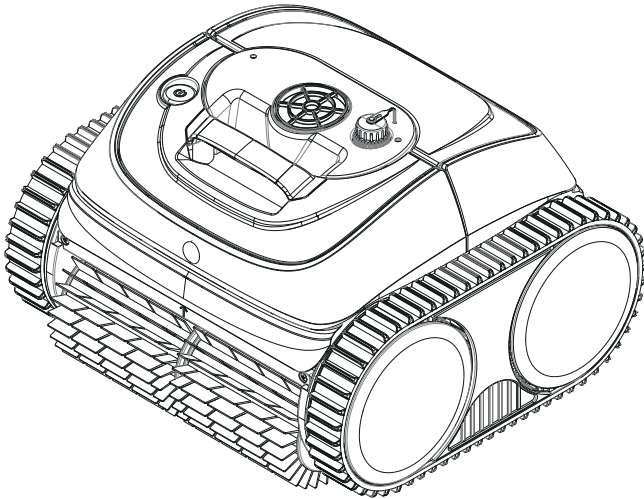

Read through the entire manual before running your new robotic pool cleaner, and keep this manual handy for your reference.

WYBOT

Thank you for choosing WYBOT products, your support means a lot to us. Continuous providing the best solution to free you up from pool cleaning and enjoy your family time is always our pursuit.

WYBOT Robotic Pool Cleaner is dedicated to serving you high efficiency, low power consumption, easy operation and thorough pool cleaning work.

Its unique appearance and reliable functions as one-button activation, powerful suction and scrubbing, fine filtration, smart navigation, remote control, and high compatibility with various pool shapes and constructions materials assure you a convenient, intelligent, and optimal pool cleaning.

Feel free to contact us by Email or visit our website with any questions. We are very glad to hear your advice on our continuous improvement.

Read the manual carefully before you use the cleaner. Your safety is the most important thing. Please read through and operate the device as per instructions, WYBOTICS Co., Ltd. is not held liable for any loss or injury caused by improper use.

Warning

Failure to operate the device as per the warnings can result in serious injury, electrocution or death.

1. Use only the accessories recommended or sold by WYBOTICS Co., Ltd.
2. Dry the charging port after each cleaning. Humidity charging socket may cause an electric shock.
3. Do not charge the cleaner when it is running (the indicator is on).
4. Use only the original and authorized power charger. Avoid charging any other devices with this charger. Improper use may result in overheating or corrosive liquid leakage from the battery.
5. Make sure the electrical outlet is protected by a ground fault circuit interrupter (GFCI) and an earth leakage interrupter (ELI).
6. Do not use a cord-damaged charger to avoid any electrical shock.
7. Do not try to use extension cord to connect the charger.
8. Never allow children to ride on the cleaner or play with it as a toy.
9. Do not allow child to operate or maintain the device.
10. Do not enter the pool when the cleaner is working in it.
11. Never expose or charge the device in flammable environments.
12. Only licensed professionals can disassemble the sealing parts of the cleaner.
13. Do not operate the cleaner while pool filter is running.

Caution

Failure to operate the device as per the cautions can cause a damage to the device or personal injury.

1. Charge the unit before first use.
2. Do not over charge the cleaner, which will reduce the battery life.
3. Charge the cleaner prior to being stored for a long time (over 6 months) to maintain an optimal battery life.
4. Remember to wash and clean the filter basket after each use.
5. Store the cleaner in a cool and ventilated place, away from direct sunshine or any heat source.
6. Use only the pool cleaner in the following water conditions:

Chlorine	Max 4 mg/L
pH	7.0 - 7.8
Temperature	41 - 95 °F (5 - 35 °C)
NaCl	Maximum 5000 PPM

CONTENTS

WYBOT C1 AT A GLANCE	01
Product External Overview	01
Product Internal Overview	02
Packing List	02
GET STARTED	03
Charge your new WYBOT C1	03
Setup your new WYBOT C1	04
<i>Connect to your App</i>	04
<i>Choose your cleaning mode</i>	05
<i>Preset your cleaning cycle via the app</i>	05
Run your new WYBOT C1	06
DO A FILTER CLEANING	08
DEVICE SPECIFICATION	09
LIMITED WARRANTY	09
HOW TO MAINTAIN YOUR DEVICE	10
FAQ & TROUBLE SHOOTING	12
CERTIFICATION	12

WYBOT C1 AT A GLANCE

Product External Overview

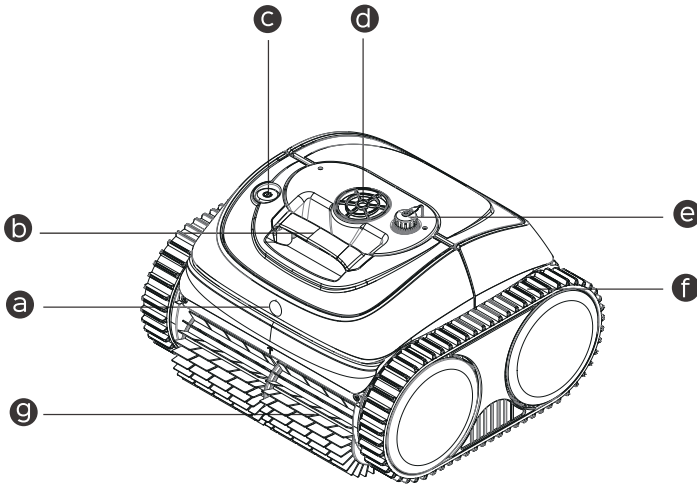

a LED Indicator

Different light colors to indicate device status

b Handle

Remove and transport the device with it

c on/off Button

Turn on/off the device

d Pump

Suck debris and pump out water through the window

e Charging Port

Connect the charging cable

f Track

Enhance device's capability in climbing walls and various obstacles

g Scrubbing Brush

Knock loose all dirt and roll them all into the device

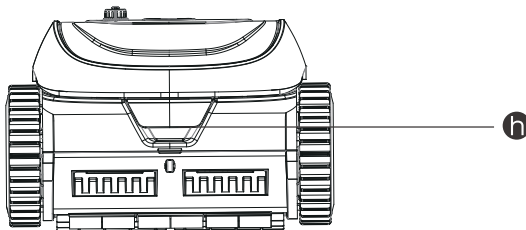

h Filter Cover Handle

Hold it and press the edge to open the cover

Product Internal Overview

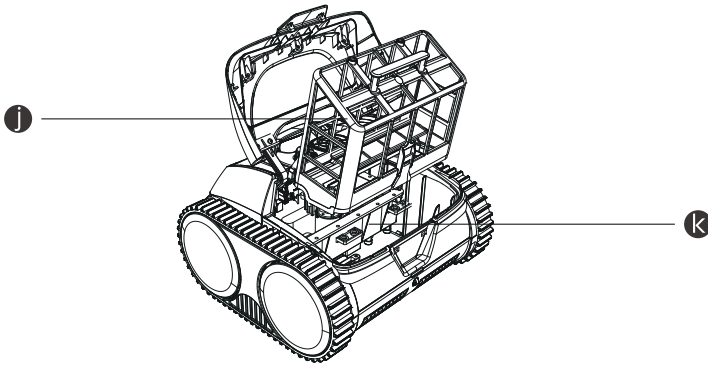

j Filter Basket





Store collected dirt and debris, need be washed after each use.

k Sealed Part

Important components are sealed there. For your safety, do not try to disassemble it without authorization.

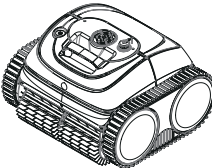
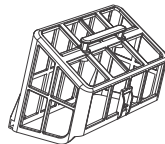
Do not operate the device when the top cover or scrubbing brushes are broken. If there is any liquid leakage from the sealing part, stop charging or running the device.

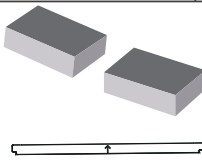
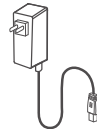
Packing List

 <p>Device x 1</p>	 <p>Filter Basket x 1</p>	 <p>Quick Start Guide x 1</p>	 <p>User Manual x 1</p>
 <p>Floating Parts</p>	 <p>Charger x 1</p>	 <p>Hook x 1</p>	

GET STARTED

Charge your new WYBOT C1



The device has a lithium-ion rechargeable battery, and you need to charge the battery before first use and when the battery is low.

Connect your device to a power outlet using the included cable and adaptor.

Note:

1. When charging, you should ensure your device at least 3m (appr. 10ft) away from the edge of the pool.
2. For reducing fire risk, keep your device and adaptor away from direct sunshine or water when charging.
3. For your important safety, you need to double check the device is powered off and the charging port is dry before charging.
4. The best charging environment is temperature at 32°F -95°F (0°C -35°C), RH at 5%-95%.

The adaptor has an indicator, which will display blue light  indicating the power supply status.

The LED indicator in the front of the device will turn starting from a flashing  light to a flashing  light during charging, and turn a solid  light when fully charged.

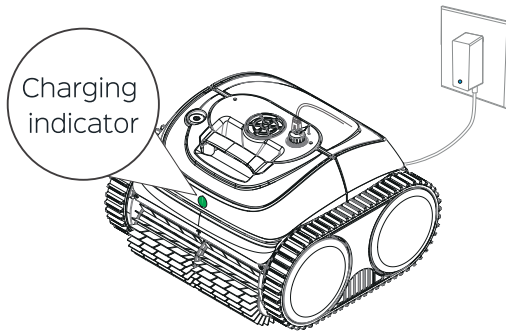

Below is the indication of the LED lights, you may refer it to know different device status.

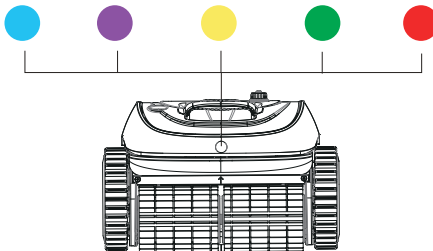

LED Light	Indication	Status
●	Solid	Power On
	Flashing	Under working
●	Solid	Connecting to App
●	Flashing	Charging in progress, low battery or under self-parking in the pool
●	Flashing	Charging in progress
	Solid	Fully charged
●	Solid or flashing	Fault

Note:

1. When yellow light flashes, you should remove your device out of water and charge it.
2. If red LED light is on, you can find solution from trouble shooting in this manual or call for service.

Setup your new WYBOT C1

You can turn on the device by pressing the on/off button. The LED indicator on the front will display a solid ● when the device is on.



Note:

The LED will continue a flashing ● indicating low battery when powering on the device, and you should charge it immediately.

Connect to your App

You can download the WYBOT App to your smart mobile device by scanning QR code below, or from Google Play or App Store.

	iOS	Android
	iOS 15.0 or later	Android 8.0 or later

Choose your cleaning mode

After connecting to your App, you can preset a suitable cleaning mode for your device. There are 5 cleaning modes, and you can see details below.

Mode	Cleaning Range
Full pool cleaning	Wall+ Floor+Waterline
Floor only	Floor
Wall only	Wall
Wall then floor	Wall *1+ Floor *1
Eco Floor	Longer runtime than 'Floor only' cleaning mode

Note:

1. You can preset your cleaning modes via App before device is put into the pool. The default mode is Wall then floor.
2. If the device restarts, it will automatically enter the cleaning mode you set last time

Preset your cleaning cycle via the app

You can start to schedule your cleaning cycle through clicking the "cycle timer" on the app, and select the one you prefer. You may refer to below for a better understanding of the working principle.

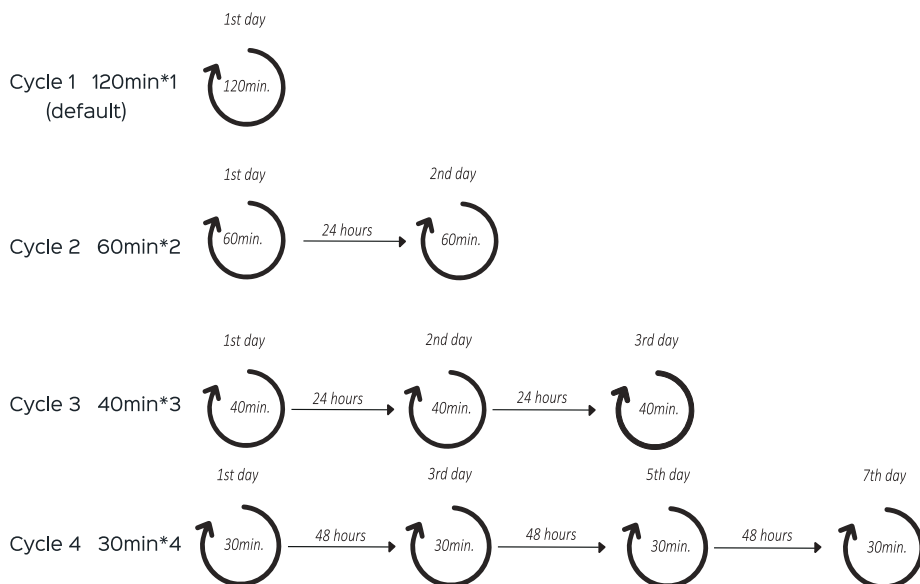

Note:

1. If you have selected a cycle cleaning mode, *you should ensure the cleaner is fully charged before use.*
2. The default cleaning cycle is one time cleaning for 2 hours.
3. If you select cycles other than the default one, *you should keep the cleaner in the pool to complete whole cycles.*

Run your new WYBOT C1

Hold the handle of the cleaner and put it into the pool within 3 minute, otherwise the device will be turned off.

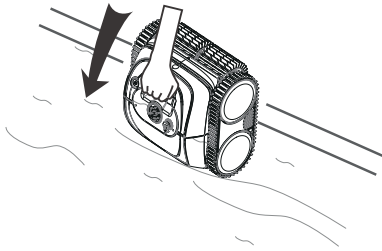

Let it sink down to the floor to empty trapped air inside.

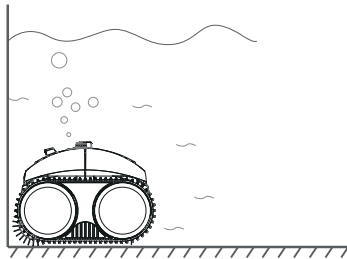
**Note:**

To achieve an optimal cleaning performance, you should ensure the water depth of the pool is at least 19.5 in (50 cm) high from the top of the device.

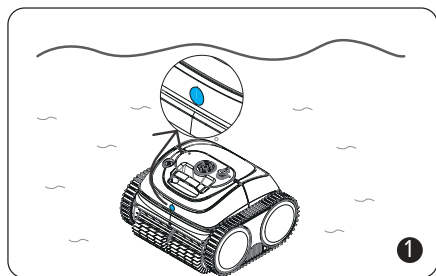

About 20 seconds of auto calibration on the floor, the indicator light will turn flashing blue. The cleaner is ready to clean.

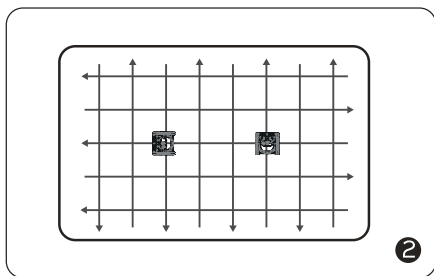

The cleaner begins to clean walls, floor and waterline as default or your set.

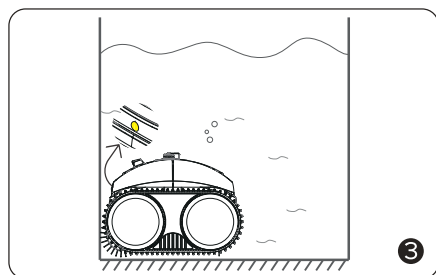

The device will automatically move to stop by the edge of wall when finishing cleaning or battery low.

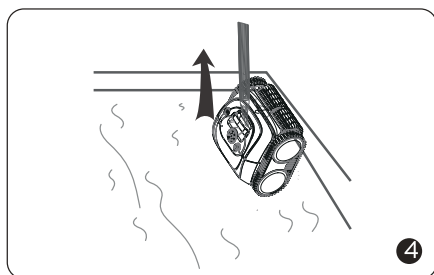

You can insert the included hook into a pool rod and lift the cleaner out of the pool.

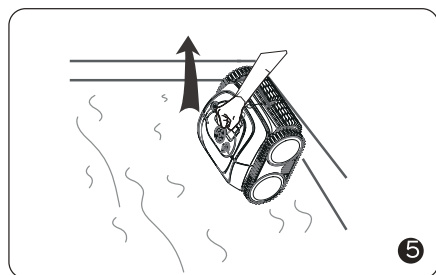

You should take the cleaner out vertically to drain inside water out quickly.

Note:

If you have preset a cleaning cycle other than the default one, you should leave the cleaner in the pool to complete the whole cycle.

DO A FILTER CLEANING

Hold the filter cover handle, press and open it.

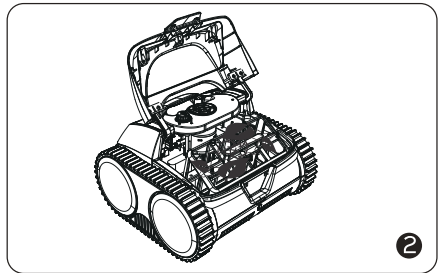
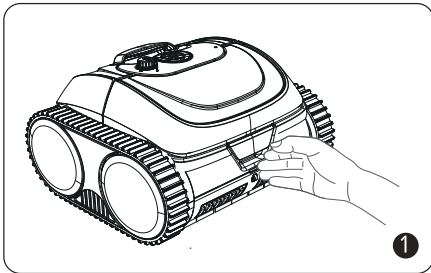

Note:

1. You should ensure the device is powered off when open the top cover.
2. You need to clean the filter basket before being dry.

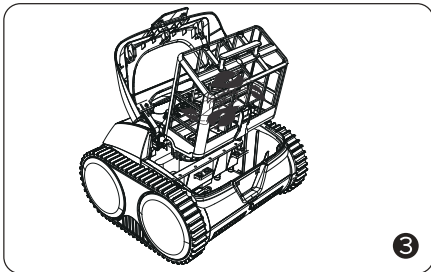

Take out the filter basket.

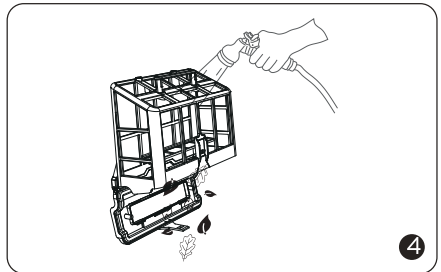

Empty all debris and rinse it with clean water.

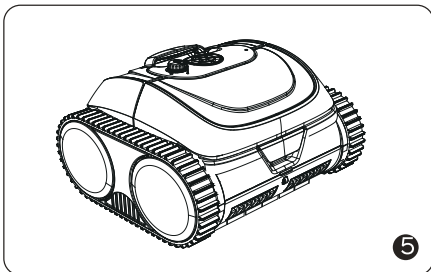

After rinsing, put the filter basket into the cleaner and close the cover.

DEVICE SPECIFICATION

Name	WYBOT C1
Pool Size	120m ² ~150m ²
Depth	9.8ft (3m)
Device Dimension	360(L)*390(W)*260(H) mm
Weight	8kg
Runtime	120min.~150min.
Charging Time	3 hours
Power	65W
Charger Input	100-240V, 50-60Hz
Charger Output	25.2V/1.5A
Battery Capacity	4600mAh
Filter	180µm
Flow Rate	11.5 m ³ /H
Moving Speed	16m/min
Water Resistance	IPX8
App Connection	Available
OTA Update	Available

LIMITED WARRANTY

1. All WYBOT pool cleaners in the market have been inspected and licensed to be sold as per local laws.
2. The warranty duration for battery, motor and PCB is two (2) years from the purchasing date. Consumable parts, including filter basket, brush, wheels etc., are beyond warranty.
3. The warranty apply only to original buyers, and not valid to resale and any other

kinds of transfer.

4. Any damages to the unit caused by improper use, unauthorized repair or disassembly are not covered by WYBOTICS Co., Ltd.'s warranty.
5. The order number or record must be presented for any claim or repair within the warranty period.

HOW TO MAINTAIN YOUR DEVICE

You should follow the steps to store your cleaner to maintain good performance.

- a) Ensure the device is powered off
- b) Dry out the cleaner and filter basket
- c) Fully charge the battery
- d) Store the cleaner in a cool and ventilated place, away from direct sunshine, heat source, frost and squeezing with an ambient temperature between 5°C/ 41°F and 45°C / 113°F.
- e) Charge the cleaner every three months to ensure an optimal battery life.

Note:

If your device do not work after a long-term low battery life or being off, please contact after-sale team for help. For your safety, do not try to disassemble it without authorization.

FAQ & TROUBLE SHOOTING

Q: What pool shapes and construction materials is the cleaner suitable for?

A: The machine can be applied to rectangle, oval, or irregular shapes of in-ground swimming pools. Applicable construction materials include PVC, gunite and other high friction materials. (Slippery materials such as tiles, mosaics, and acrylic may not work well, and you need to do some modification.)

Q: Will obstacles such as steps, shallow water areas, drains, slopes etc. in the swimming pool affect the running?

A: The machine can climb steps, drains, and shallow water areas.

If you encounter the following situations when using the cleaner, you can check the table and solve them by yourself.

Note:

If you can not find a solution from the table, please contact after-sale team.

No.	Issues	Details	Possible Causes	Suggested Solution
1	Device does not work	A solid red light	Impeller is stuck	Check the impeller and clean foreign
		A flashing red light	Motor protection	Restart
		A flashing red light	Not put the device into the water or the pool water is too shallow	Restart and put it into the pool immediately. Be sure the water depth is over 0.5m.
		A flashing yellow light	Battery low	Fully charge the device and restart
2	Unable to charge	Charger light flashes	Poor contact	Re-plug the charger
3	Do not climb walls		Slippery construction materials	Stick floating parts (Contact service team for instruction.)
			Too dirty water	Clean the filter basket
4	Abnormal wall climbing	Climbing slowly	Filter basket blocked	Clean the filter basket
		Sinking down away from wall or floating on the water	Intake air	Stick floating parts (Contact service team for instruction.)
			Filter basket blocked	Clean the filter basket
5	only clean part area and cannot clean the entire pool		Wrong cleaning mode	Connect to the App and re-choose a suitable cleaning mode
			Firmware not the latest	Connect to the App and update the firmware
6	front side up when on the floor		Filter basket blocked	Clean the filter basket
7	Do not clean as set cleaning path		Encounter Obstacles	Clean the filter basket
	Unable to connect to the App		Device power off	Restart
8	The APP cannot be connected when the device is in the pool		Not available	Connect the device on the shore

CERTIFICATION

WYBOT robotic pool cleaners have passed all performance and reliability tests and also has obtained relevant certifications from the countries in which they are sold. you can rest assured.



WYBOT CUSTOMER CARE

Due to the need for continuous products improvement, the products in the manual are subject to the real products, and WYBOTICS Co., Ltd. reserves the right to update products.

If you encounter any problems during use, please contact after-sale team. For more details, please contact WYBOTICS website www.wybotpool.com

Wybot Customer Service:

Email: support@wybotpool.com

Facebook: [@WybotPool](https://www.facebook.com/WybotPool)

Tel: 1-866-777-6655

WYBOT

www.wybotpool.com

Email: support@wybotpool.com

Facebook: @WybotPool

WYBOTICS CO.,LTD

No.30, Zhongnan 4th Street West Zone, TEDA Tianjin, China

All trade names are registered trademarks of respective manufacturers listed.

