

# WYBOT

## Robotic Pool Cleaner User Manual

WYBOT M1(WY310)

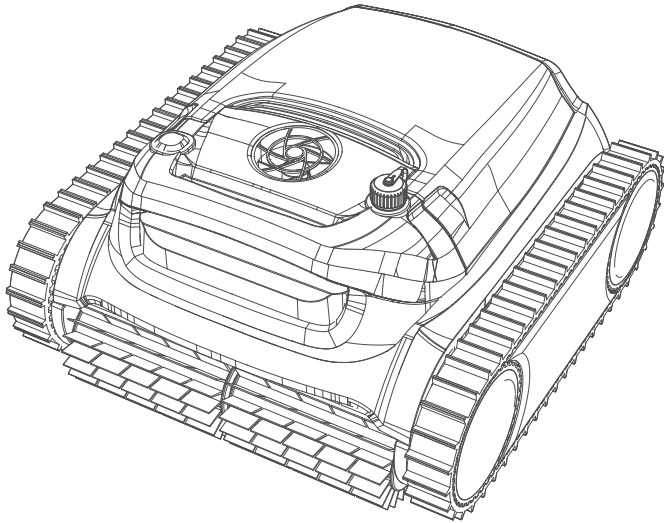

Read through the entire manual before running your new robotic pool cleaner, and keep this manual handy for your reference.

Copyright© 2024 WYBOTICS Co., Ltd. All Rights Reserved.

# WYBOT

[www.wybotpool.com](http://www.wybotpool.com)

E-mail: [support@wybotpool.com](mailto:support@wybotpool.com)

Facebook: @WybotPool

WYBOTICS CO.,LTD

No.30,Zhongnan 4th Street West Zone,TEDA Tianjin,China

All trade names are registered trademarks of respective manufacturers listed.



# WYBOT

Thank you for choosing WYBOT products, your support means a lot to us. Continuous providing the best solution to free you up from pool cleaning and enjoy your family time is always our pursuit.

WYBOT Robotic Pool Cleaner is dedicated to serving you high efficiency, low power consumption, easy operation and thorough pool cleaning work.

Its unique appearance and reliable functions as one-button activation, powerful suction and scrubbing, fine filtration, smart navigation, remote control, and high compatibility with various pool shapes and constructions materials assure you a convenient, intelligent, and optimal pool cleaning.

Feel free to contact us by Email or visit our website with any questions. We are very glad to hear your advice on our continuous improvement.

Read the manual carefully before you use the cleaner. Your safety is the most important thing. Please read through and operate the device as per instructions, WYBOTICS Co., Ltd. is not held liable for any loss or injury caused by improper use.

## Warning

Failure to operate the device as per the warnings can result in serious injury, electrocution or death.

1. Use only the accessories recommended or sold by WYBOTICS Co., Ltd.
2. Dry the charging port after each cleaning. Wet charging port may cause an electric shock.
3. Do not charge the cleaner when it is running (the indicator is on).
4. Use only the original and authorized power charger. Avoid charging any other devices with this charger. Improper use may result in overheating or corrosive liquid leakage from the battery.
5. Make sure the electrical outlet is protected by a ground fault circuit interrupter (GFCI) and an earth leakage interrupter (ELI).
6. Do not use a cord-damaged charger to avoid any electric shock.
7. Do not try to use extension cord to connect the charger.
8. Never allow children to ride on the cleaner or play with it as a toy.
9. Do not allow child to operate or maintain the device.
10. Do not enter the pool when the cleaner is working in it.
11. Never expose or charge the device in flammable environments.
12. Only licensed professionals can disassemble the sealed parts of the cleaner.

## Caution

Failure to operate the device as per the warnings can cause a damage to the device or personal injury.

1. Charge the unit before first use.
2. Do not over charge the cleaner, which will reduce the battery life.
3. Charge the cleaner prior to being stored for a long time (over 6 months) to maintain an optimal battery life.
4. Do not operate the cleaner while pool filter is running.
5. Remember to wash and clean the filter basket after each use.
6. Store the cleaner in a cool and ventilated place, away from direct sunshine or any heat source.
7. Use only the pool cleaner in the following water conditions:

Chlorine	Max 4 mg/L
pH	7.0 - 7.8
Temperature	41 - 95 °F (5 - 35 °C)
NaCl	Maximum 5000 PPM

# CONTENTS

<b>WYBOT M1(WY310) AT A GLANCE</b>	<b>01</b>
Product External Overview	01
Product Internal Overview	02
Packing List	02
<b>GET STARTED</b>	<b>03</b>
Charge your new WYBOT M1(WY310)	03
Setup your new WYBOT M1(WY310)	04
<i>Connect to your App</i>	<i>05</i>
<i>Choose your cleaning mode</i>	<i>05</i>
Run your new WYBOT M1(WY310)	06
<b>DO A FILTER CLEANING</b>	<b>07</b>
<b>DEVICE SPECIFICATION</b>	<b>09</b>
<b>LIMITED WARRANTY</b>	<b>09</b>
<b>HOW TO MAINTAIN YOUR DEVICE</b>	<b>10</b>
<b>FAQ &amp; TROUBLE SHOOTING</b>	<b>10</b>
<b>CERTIFICATION</b>	<b>12</b>
<b>WYBOT CUSTOMER CARE</b>	<b>12</b>

## Product External Overview

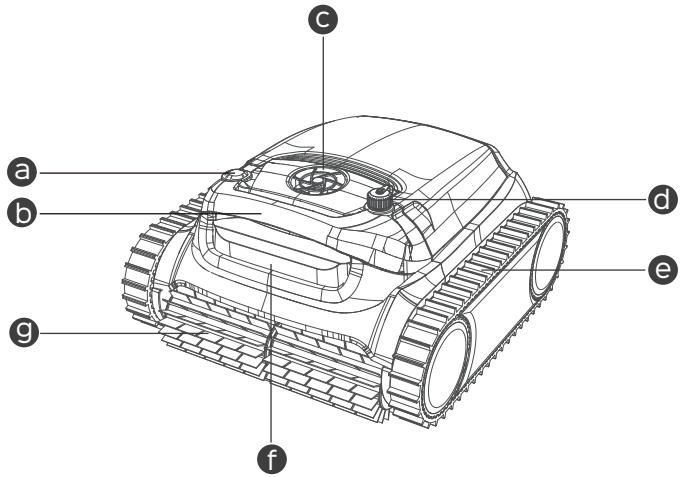

**a on/off Button**

Turn on/ turn off the device

**b Handle**

Remove and transport the device with it

**c Pump**

pump out water through the window

**d Charging Port**

Connect the charger

**e Track**

Enhance device's capability in climbing walls and various obstacles

**f LED Indicator**

Different light colors to indicate device status

**g Scrubbing Brush**

Knock loose all dirt and roll them all into the device

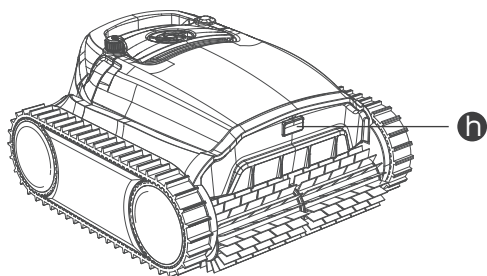

**h Lid Open Button**

Open the cover to take out the filter basket

## Product Internal Overview

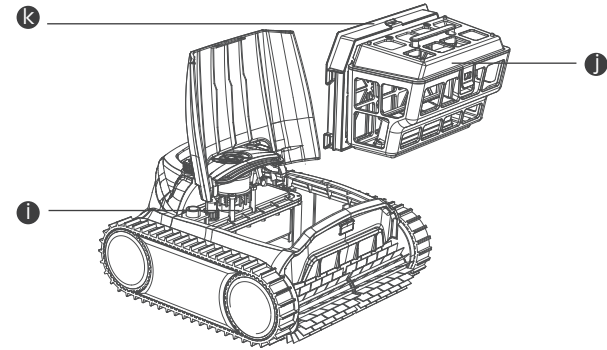

**i Sealed Part**

Important components are sealed there. For your safety, do not try to disassemble it without authorization.

**j Filter Basket (180µm)**





Store collected dirt and debris, need to be installed before cleaning, and washed after each use.

**k Filter Foam (Cotton foam)**

An auxiliary filter to help trap the fine dirty particles. Please do not install it when the pool water is heavy dusty, it may influence the operation of the cleaner. Recommend to use it for floor cleaning.

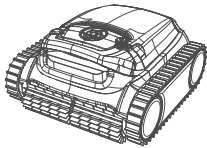
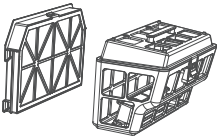
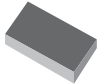
Do not operate the device when the top cover or scrubbing brushes are broken. If there is any liquid leakage from the sealed part, stop charging or running the device.

## Packing List

 <p>Device x 1</p>	 <p>Filter x 2</p>	 <p>Adhesive Block x 6</p>	
 <p>User Manual x 1</p>	 <p>Quick Start Guide x 1</p>	 <p>Charger x 1</p>	 <p>Hook x 1</p>

## GET STARTED

### Charge your new WYBOT M1(WY310)

The device has a lithium-ion rechargeable battery, and you need to charge the battery before first use and when the battery is low. Connect your device to a power outlet using the included cable and adaptor.

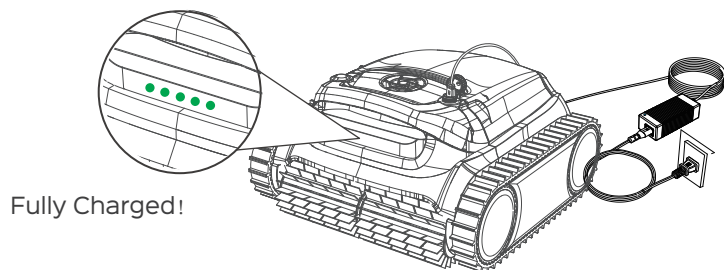

Fully Charged!

- For your important safety, you need to double check whether the device powers off and charging port is dry before charging.
- For reducing fire risk, keep your device and adaptor away from direct sunshine or water when charging.







#### Note:

1. When charging ,you should ensure your device at least 3m (appr. 10ft) away from the edge of the pool.
2. The best charging environment is temperature at 32°F -95°F (0°C -35°C ), RH at 5%-95%.

The adaptor has an indicator, Which will display blue light  indicating the power supply status.





The LED indicator in the front of the device will turn a flashing green light whe charging, and all LED lights turn a solid  when fully charged.

Below is the indication of the LED lights, you may refer it to know different device status.

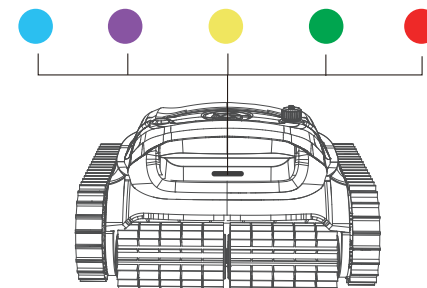

 Quantity	Battery Level (%)
	0~20
	20-40
	40-60
	60-80
	80-100

Below is the indication of the LED lights, you may refer to it to know different device status.



LED Light	Indication	Status
	Solid	Power On
	Flashing	Under working
	Solid	Connecting to App
	Flashing	Low battery or under self-parking in the pool
	Flashing	Charging in progress
	Solid	Fully charged
	Solid or flashing	Fault

### Setup your new WYBOT M1(WY310)

Turn on the device by pressing the on/off button. The LED indicator on the front will display a solid green  to display current battery level and then a solid blue  when the device is on. If the battery level is too low to start cleaning, the LED lights will show a flashing .

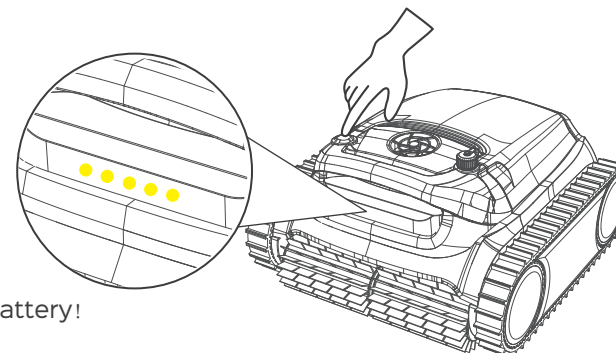

Low battery!

**Note:**

1. When yellow light flashing ,you should remove your device out of water and charge it.
2. If red LED light is on, you can find solution from trouble shooting in this manual or call for service.

**Connect to your App**

You can download the WYBOT App to your smart mobile device by scanning QR code below, or from Google Play or App Store.

	iOS	Android
	iOS 15.0 or later	Android 8.0 or later

**Choose your cleaning mode**

After connecting to your App, you can choose a cleaning mode for your device. There are 7 cleaning modes, and you can see it below.

Mode	Cleaning Coverage
Standard Full Pool	Wall+ Floor+Waterline
Floor Only	Pool Floors
Wall Only	Pool Walls
Waterline	Pool Waterline
Wall then floor (Combo)	Wall *1+ Floor *1
Eco floor	Eco mode, floor cleaning only
Turbo Floor	Strong cleaning, floor cleaning only

**Note:**

1. You can modify your cleaning modes via App when ot of pool. The default mode is Wall then floor.
2. If the device restarts, it will automatically enter the cleaning mode you set last time.

**Run your new WYBOT M1(WY310)**

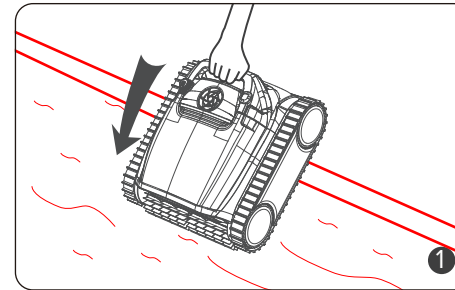

Hold the handle of the cleaner, and put it into the pool vertically.

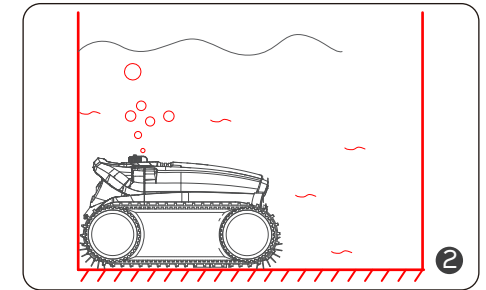

Let it sink down to the floor to empty trapped air inside.

**Note:**

To achieve an optimal cleaning performance, you should ensure the water depth of the pool is at least 19.5 in (50 cm) high from the top of the device.

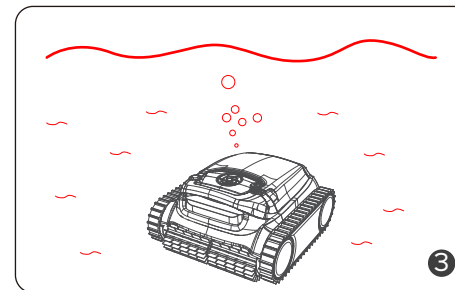

About 30 seconds of self-calibration, the indicator light will turn to be a flashing blue. The cleaner is ready to clean.

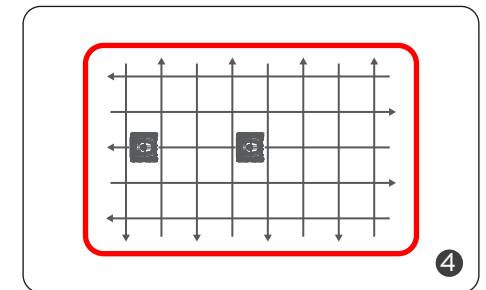

The cleaner begins to clean walls, floor and waterline as default or your set through App.

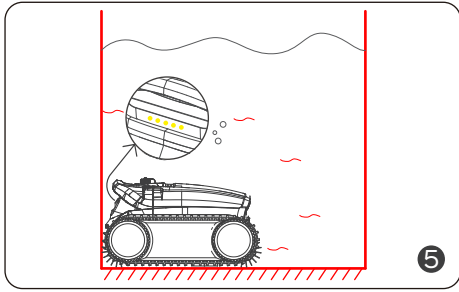

The device will automatically move to stop by the edge of wall when finishing cleaning or battery low.

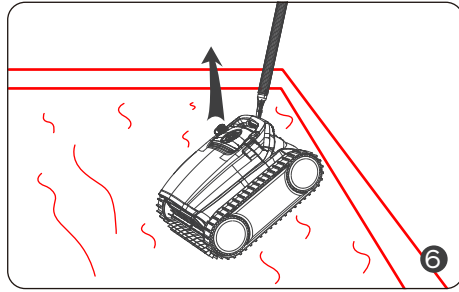

You can insert the included hook into a pool pole and lift the cleaner out of the pool.

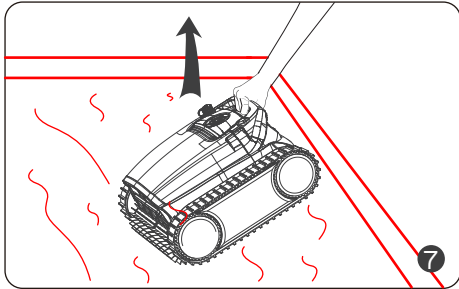

You should take the cleaner out vertically to drain inside water out quickly.

## DO A FILTER CLEANING

Press the filter cover handle and lift the cover up.

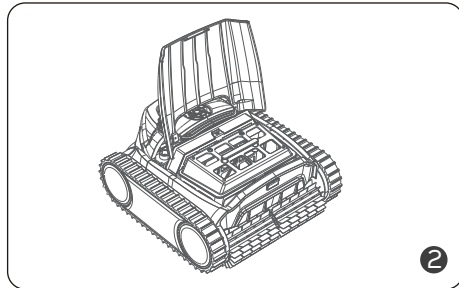
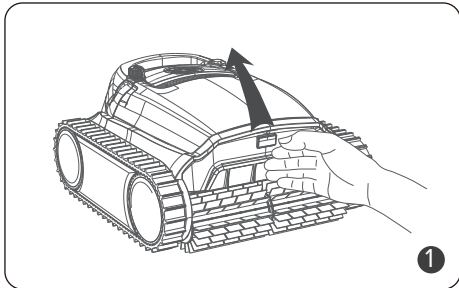

### Note:

1. You should ensure the device is power off when open the top cover.
2. You need to clean the filter basket after each use.

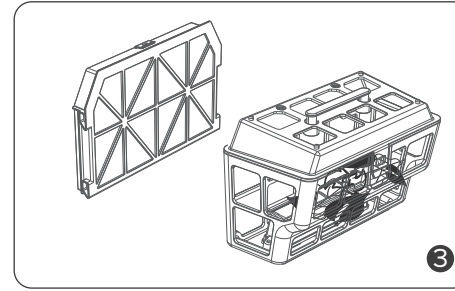

Take out the filter basket.

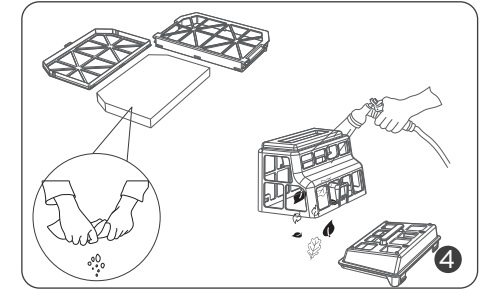

Empty all debris and rinse it with clean water.

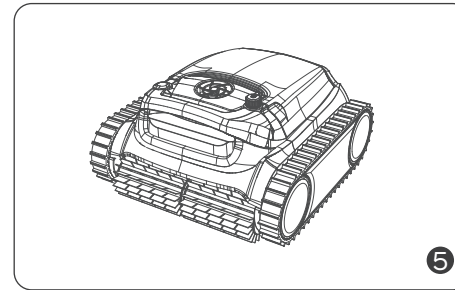

After rinsing, put the filter basket into the cleaner and close the cover.

- As electric components inside the cleaner, store the cleaner in a cool and ventilated place, away from direct sunshine or any heat source.
- Charge the cleaner prior to being stored for a long time (over 6 months) to maintain an optimal battery life.

## DEVICE SPECIFICATION

Model	WYBOT M1(WY310)
Pool Size	Up to 4305sp.ft (400m <sup>2</sup> )
Depth	9.8ft (3m)
Device Dimension	460 (L)*420(W)*230(H) mm 18 (L)*17(W)*9(H) inch
Weight	11 Kg
Runtime	5 hours(Eco floor mode)
Charging Time	3.5 hours
Voltage	Battery/25.5V
Power	120W
Charger Input	100-240V, 47-63Hz
Charger Output	29.4V/4A
Battery Capacity	10000mAh
Filtration	Double-level
Flow Rate	15m <sup>3</sup> /H (3963GPH)
Moving Speed	10m/min.(36ft/min.)
Water Resistance	IPX8
OTA upgrading	Available
App Connection	Available

## LIMITED WARRANTY

- All WYBOT pool cleaners in the market have been inspected and licensed to be sold as per local laws.
- The warranty duration for battery, motor and PCB is two (2) years from the purchasing date. Consumable parts, including filter basket, brush, wheels etc., are beyond warranty.
- The warranty apply only to original buyers, and not valid to resale and any other

kinds of transfer.

- Any damages to the unit caused by improper use, unauthorized repair or disassembly are not covered by WYBOTICS Co., Ltd.'s warranty.
- The order number or record must be presented for any claim or repair within the warranty period.

## HOW TO MAINTAIN YOUR DEVICE

You should follow the steps to store your cleaner to maintain good performance.

- Ensure the device is power off
- Dry out the cleaner and filter basket
- Fully charge the battery
- Store the cleaner in a cool and ventilated place, away from direct sunshine, heat source, frost and squeezing with an ambient temperature between 5°C/ 41°F and 45°C / 113°F.
- Charge the cleaner every three months to ensure an optimal battery life.

### Note:

If your device do not work after a long-term low battery life or being off, please contact after-sale team for help. For your safety, do not try to disassemble it without authorization.

## FAQ & TROUBLE SHOOTING

- Q: What pool shapes and construction materials is the cleaner suitable for?  
 A: The machine can be applied to rectangle, oval, or irregular shapes of in-ground swimming pools. Applicable construction materials include PVC, gunite, tile and other materials.
- Q: Will obstacles such as steps, shallow water areas, drains, slopes etc. in the swimming pool affect the running?  
 A: The machine can climb steps, drains, and shallow water areas. The above obstacles may influence its cleaning path, but will not affect the operation of the machine.

If you encounter the following situations when using the cleaner, you can check the table and solve them by yourself.

### Note:

If you can not find a solution from the table, please contact after-sale team.

No.	Issues	Details	Possible Causes	Suggested Solution
1	Device does not work	A solid red light	Impeller is stuck	Check the impeller and clean foreign
		A flashing red light	Motor protection	Restart
		A flashing red light	Not put the device into the water or the pool water is too shallow	Restart and put it into the pool immediately. Be sure the water depth is over 0.5m.
		A breathing yellow light	Battery low	Fully charge the device and restart
2	Unable to charge	Charger light flashes	Poor contact	Re-plug the charger
3	Do not climb walls	Slippery construction materials		Stick adhesive blocks (Contact after-sale team for instruction)
		Too dirty water		Clean the filter basket
4	Abnormal wall climbing	Climbing slowly	Filter basket blocked	Clean the filter basket
		Sinking down away from wall or floating on the water	Intake air	Stick adhesive blocks (Contact after-sale team for instruction)
			Filter basket blocked	Clean the filter basket
5	only clean part area and cannot clean the entire pool	Wrong cleaning mode		Connect to the App and re-choose a suitable cleaning mode
		Firmware not latest		Connect to the App and update the firmware
6	front side up when on the floor	Filter basket blocked		Clean the filter basket
7	Do not clean as set cleaning path	Encounter Obstacles		Clean the filter basket
	stuck at water drains	Drain height is over 3cm		Help the machine away from the obstacle
	Unable to connect to the App	Device power off		Restart
8	The APP cannot be connected when the device is in the pool	Not available		Connect the device on the shore

## CERTIFICATION

WYBOT robotic pool cleaners have passed all performance and reliability tests and also has obtained relevant certifications from the countries in which they are sold. you can rest assured.



## WYBOT CUSTOMER CARE

Due to the need for continuous products improvement, the products in the manual are subject to the real products, and WYBOTICS Co., Ltd. reserves the right to update products.

If you encounter any problems during use, please contact after-sale team. For more details, please contact WYBOTICS website [www.wybotpool.com](http://www.wybotpool.com)

Wybot Customer Service:

Email: [support@wybotpool.com](mailto:support@wybotpool.com)

Facebook: @WybotPool

Tel: 1-866-777-6655