

Massivsauna

Basic

CORNER

195 x 187 x 204 cm

MONTAGEANLEITUNG
Deutsch



DE

EN

FR

IT

PL

PT

Inhaltsverzeichnis

1. Montage Vorbereitung	3
1.1. Benötigtes Werkzeug	4
1.2. Wartung und Reinigung	5
1.3. Entsorgung	5
1.4. Stückliste Basic Corner	6
2. Montage der Kabine	8
2.1. Montage der Wandelemente	8
2.2. Montage Dach	13
2.3. Montage Lüftungsschieber	15
2.4. Montage Inneneinrichtung	16
2.5. Montage Zubehör	18
2.6. Montage Türrahmen	20
2.7. Montage Abdeckleisten	22
3. Grundriss	24

1. Montage Vorbereitung

Lesen Sie diese Montageanleitung gut durch und bewahren Sie sie in der Nähe der Sauna auf. So können Sie jederzeit Produktinformationen nachlesen.



Sie finden diese Montageanleitung auch im Downloadbereich unserer Webseite auf www.sentiotec.com/downloads.

Wichtige Hinweise:

- Kontrollieren Sie, bevor Sie mit der Arbeit beginnen, anhand der Stückliste, ob alle Einzelteile auch tatsächlich mitgeliefert wurden. Sollten Einzelteile ausnahmsweise fehlen, benachrichtigen Sie spätestens 14 Tage nach Erhalt der Kabine Ihren Händler.
- Der Raum, in dem die Saunakabine montiert wird, muss trocken sein und eine entsprechende Luftzirkulation gewährleisten.
- Der Fußboden muss waagrecht und eben sein, bevorzugt Stein- oder Fliesenboden.
- Für die Montagearbeiten der Kabine wird eine Mindestraumhöhe von 230 cm benötigt.
- Es muss ein Wandabstand von mindestens 5 cm eingehalten werden.
- Die Innen zu verwendenden Holzteile dürfen nicht mit Imprägniermittel behandelt werden.
- Für die Montage benötigen Sie einen Helfer.
- Holz ist ein Naturprodukt, das trotz guter Lagerung aufquellen, schwinden oder sich verziehen kann. Aus diesem Grund kann es vorkommen, dass bei der Montage etwas Kraft aufgebracht werden muss.
- Alle Verschraubungen müssen vorgebohrt werden.

Achtung!

Der Elektroanschluss darf nur durch eine Elektrofachkraft oder eine vergleichsweise qualifizierte Person ausgeführt werden.

1.1. Benötigtes Werkzeug

- Hammer und Beilageholz oder einen Gummihammer
- Akkuschauber mit Bits für Kreuzschrauben und Torx
- Rollmaßband
- Bohrer mit Durchmesser 3 mm, 10 mm, 20 - 30 mm (für Stromkabel Saunaofen)
- Wasserwaage
- Innensechskant-Schlüssel 1,5 mm
- Universalmesser
- Leiter



Dieses Symbol kennzeichnet Tipps und nützliche Hinweise



Vorbohren



Ablängen auf Naturmaß mit Feinsäge



Überprüfung des rechten Winkel:

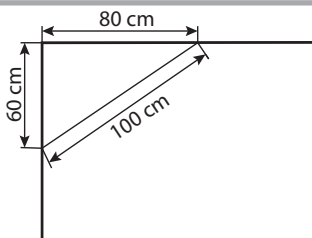

Vorsichtiger Umgang mit Glas: Besondere Vorsicht gilt den Glaskanten - Gehärtetes Glas kann bei Stößen in kleine Scherben zerspringen. Legen Sie ein Schutzpolster (z.Bsp.: Verpackungs-Karton) unter die Glaskante.

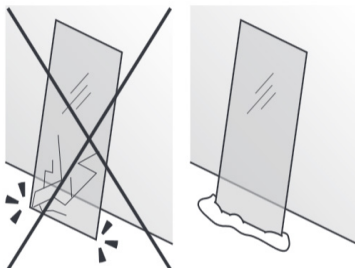

1.2. Wartung und Reinigung

- Die Sauna sollte mit einem feuchten Tuch gereinigt werden. Verwenden Sie nur warmes Wasser - keine Reinigungsmittel.
- Wird die Sauna längere Zeit nicht benutzt, empfehlen wir, die Kabine einmal im Monat aufzuheizen.



Harzgallen sind kein Reklamationsgrund. Da in Fichtenholz immer wieder Harzgallen vorkommen und man beim Aussortieren nicht erkennen kann in welcher Tiefe diese sich befinden.

Wenn diese knapp unter der Oberfläche sind brechen sie bei Hitzeentwicklung auf und „bluten“ aus.

Das ausgelaufene Harz kann man mit einem Aceton gedrängtem Lappen entfernen. Wenn lediglich Harztropfen entstehen, lassen Sie diese aushärten und schaben sie anschließend mit einem Messer vorsichtig ab.

DE

1.3. Entsorgung



- Entsorgen Sie die Verpackungsmaterialien nach den gültigen Entsorgungsrichtlinien.
- Altgeräte enthalten wiederverwendbare Materialien, aber auch schädliche Stoffe. Geben Sie Ihr Altgerät deshalb auf keinen Fall in den Restmüll, sondern entsorgen Sie das Gerät nach den örtlich geltenden Vorschriften.

1.4. Stückliste Basic Corner

Az	Bezeichnung	Maß
Wandelemente		
1	Wandelement Rückwand unten mit Lüftungsausschnitt	185 x 102 x 4 cm
1	Wandelement Rückwand links unten	185 x 102 x 4 cm
1	Wandelement linke Seite unten	126,8 x 102 x 4 cm
1	Wandelement rechte Seite unten	122,8 x 102 x 4 cm
2	Wandelemente Rückwand oben	185 x 108,8 x 4 cm
1	Wandelement mit Glas linke Seite oben	126,8 x 108,8 x 4 cm
1	Wandelement mit Glas rechte Seite oben	122,8 x 108,8 x 4 cm
1	Türstock	204 x 88 x 4 cm
Dachelemente		
1	Dachelement	176 x 92 x 5,7 cm
1	Dachelement schräg	176 x 92 x 5,7 cm
Auflageleisten		
1	Dachauflageleiste	181 x 4 x 4 cm
1	Dachauflageleiste	169 x 4 x 4 cm
1	Dachauflageleisten 1 x 45°	126,3 x 4 x 4 cm
1	Dachauflageleisten 1 x 45°	118,3 x 4 x 4 cm
1	Dachauflageleiste 2 x 45°	88,7 x 4 x 4 cm
2	Abdeckleisten außen Ecken	204 x 8 x 1,5 cm
4	Abdeckleisten außen Ecken 1 x 67°	204 x 8 x 1,5 cm
4	Abdeckleisten innen Ecken 1 x 67°	204 x 6,5 x 1,5 cm
2	Abdeckleisten außen Türe	69,3 x 8 x 1,5 cm
2	Abdeckleisten innen Türe	67,7 x 8 x 1,5 cm
1	Dachabdeckleiste innen	176 x 8 x 1,5 cm
1	Kabelabdeckleiste	194 x 4 x 3 cm
3	Bankauflageleisten	50 x 4 x 4 cm
2	Bankauflageleiste	100 x 4 x 4 cm

Az	Bezeichnung	Maß
Inneneinrichtung		
2	Bänke	184 x 50 x 8 cm
1	Bank	126,5 x 50 x 8 cm
2	Leisten Ofenschutzgitter	55 x 8 x 1,5 cm
4	Leisten Ofenschutzgitter	46,5 x 8 x 1,5 cm
2	Leisten Ofenschutzgitter	71 x 3 x 3 cm
2	Leisten Ofenschutzgitter	39 x 3 x 3 cm
1	Kopfstütze	30 x 28 cm
1	Lampenschutzgitter	52 x 24,5 x 2,7 cm
1	Lüftungsschieber	52 x 14 x 1,5 cm
Glaselemente		
1	Türrahmen mit Glastür	178,3 x 73,5 x 4 cm
Zubehör		
1	Türgriff Set	
1	Saunaleuchte	
1	3 Lfm. Silikonkabel 5 x 2,5mm ²	
1	3 Lfm. Silikonkabel 3 x 1,5mm ²	
1	Montagematerialset	
1	Montageanleitung	

2. Montage der Kabine

Beachten Sie dazu den Grundrissplan auf Seite 26.

2.1. Montage der Wandelemente

Beginnen Sie mit dem Unterteil der Rückwand (Lüftungsschieber) und der Rückwand links. Die Unterteile sind durch die überstehenden Verbindungsleisten erkennbar.



Verschrauben Sie die Rückwand mit der Seitenwand.
3 Stk. Schrauben 5 x 80 mm



Wiederholen Sie dies mit der rechten und linken Seitenwand.
6 Stk. Schrauben 5 x 80 mm



Überprüfen Sie die rechten Winkel, bevor Sie weitere Wandelemente verschrauben. Beachten Sie den Tipp auf Seite 4.



DE

Montage Wandelemente oben

Bei der Montage der Oberteile beginnen Sie wieder mit der Rückwand. Achten Sie auf den bündigen Abschluss mit den Verbindungsleisten der unteren Wandelemente.

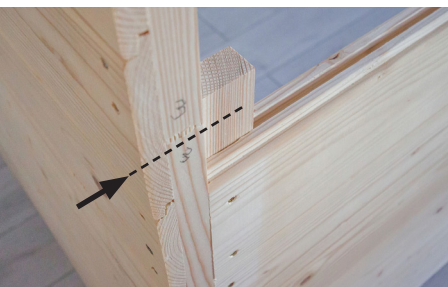
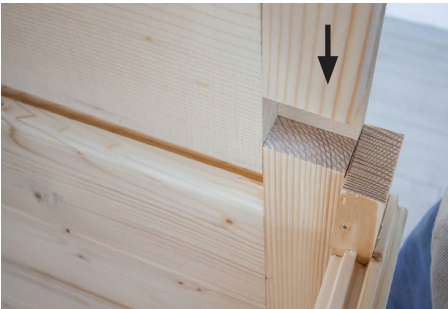

Verschrauben Sie die obere Rückwand beidseitig mit der überstehenden Leiste der unteren Rückwand. 2 Stk. Schrauben 5 x 80 mm

Bei der Montage der oberen Wandelemente achten Sie auf den bündigen Abschluss mit den Verbindungsleisten der unteren Wandelemente. Verschrauben Sie die oberen Wandelemente miteinander, je Wandelement 3 Stk. Schrauben 5 x 80 mm



Beachten Sie, dass das obere Wandelement jeweils mit der überstehenden Leiste des unteren Wandelements verschraubt sein muss.

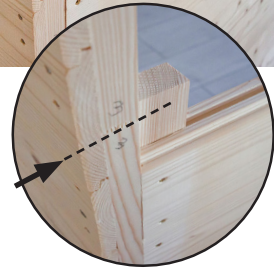
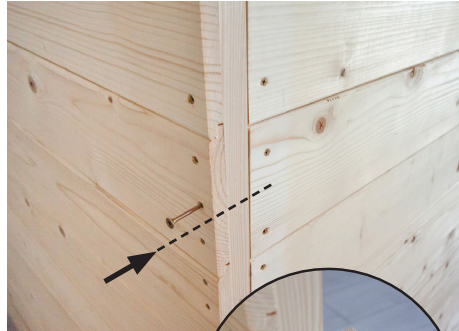



DE



Montage Türstock



6 Stk. Schrauben 5 x 100 mm

2.2. Montage Dach Dachauflageleisten



DE

16 Stk. Schrauben 4 x 70 mm



Dachelemente



Bohrer 3 mm, 14 Stk. Schrauben 5 x 80 mm



Bohrer 3 mm, 8 Stk. Schrauben 3,5 x 40 mm

DE

2.3. Montage Lüftungsschieber



Bohrer 3 mm, 4 Stk. Schrauben 3,5 x 40 mm

2.4. Montage Inneneinrichtung

Bankauflageleisten

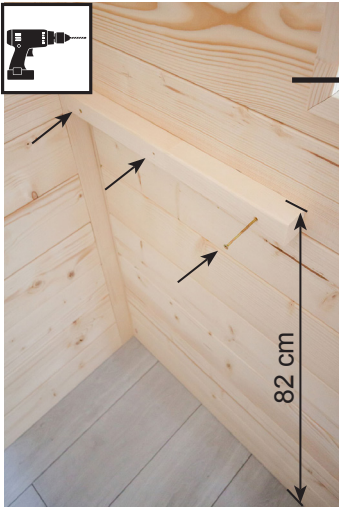

Bohrer 3 mm, 6 Stk. Schrauben 5 x 70 mm

Wiederholen Sie dies auf der gegenüberliegenden Seite und an der Vorderwand laut folgender Abbildung.

9 Stk. Schrauben 5 x 70 mm

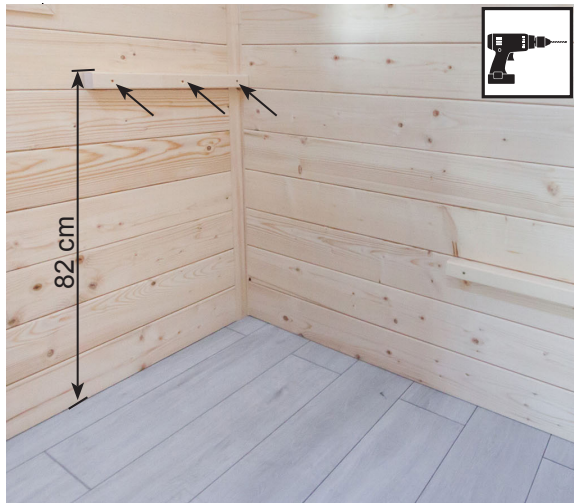
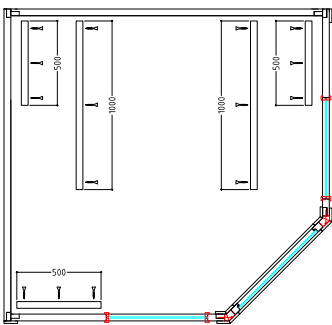

Bank



DE



Bohrer 3 mm, 3 Stk. Schrauben 5 x 50 mm



2.5. Montage Zubehör Saunaleuchte



Leuchtmittel einsetzen
(nicht im Lieferumfang enthalten)



Bohrer 3 mm, 2 Stk. Schrauben



4 Stk. Schrauben 3,5 x 40 mm

Ofenschutzgitter und Kabelabdeckleiste



Montieren Sie die Kabelabdeckleiste und den Saunaofen bevor Sie das Ofenschutzgitter an der Wand befestigen.

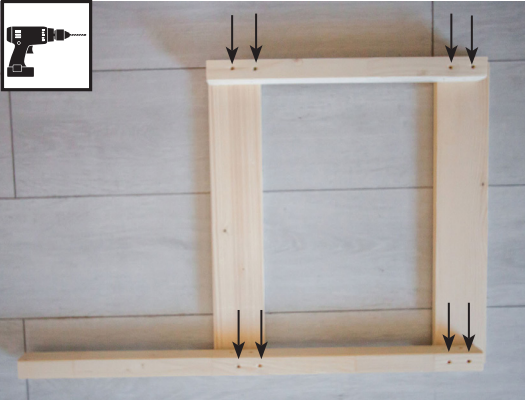

20 Stk. Schrauben 3,5 x 40 mm



DE



4 Stk. Schrauben 3,5 x 40 mm

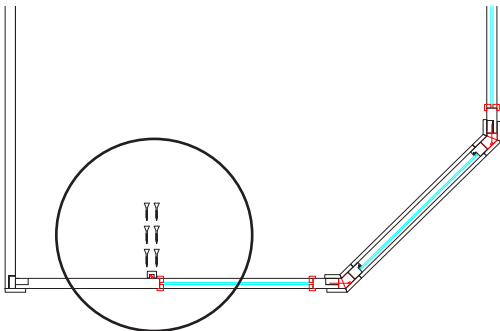

6 Stk. Schrauben 4 x 60 mm



2.6. Montage Türrahmen



6 Stk. Schrauben 4 x 70 mm

Türgriff und Überschublech

Montieren Sie das Überschublech in Höhe der Bohrungen in der Glastür



2 Stk. Schrauben 5 x 90 mm

2.7. Montage Abdeckleisten

Abdeckleisten innen Ecken



Bohrer 3 mm, 32 Stk. Schrauben 3,2 x 40 mm

Abdeckleisten außen Ecken



Bohrer 3 mm, 48 Stk. Schrauben 3,2 x 40 mm

Abdeckleisten Türe außen und innen



Bohrer 3 mm, 24 Stk. Schrauben 3,2 x 40 mm

DE

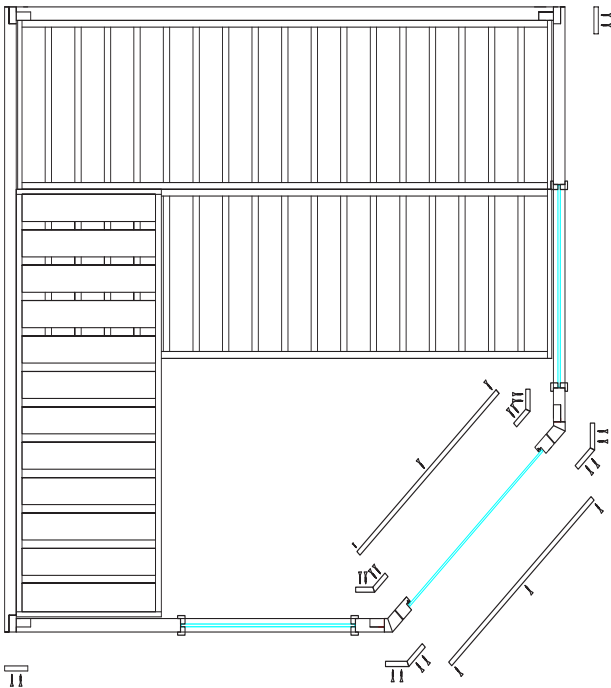

3. Grundriss

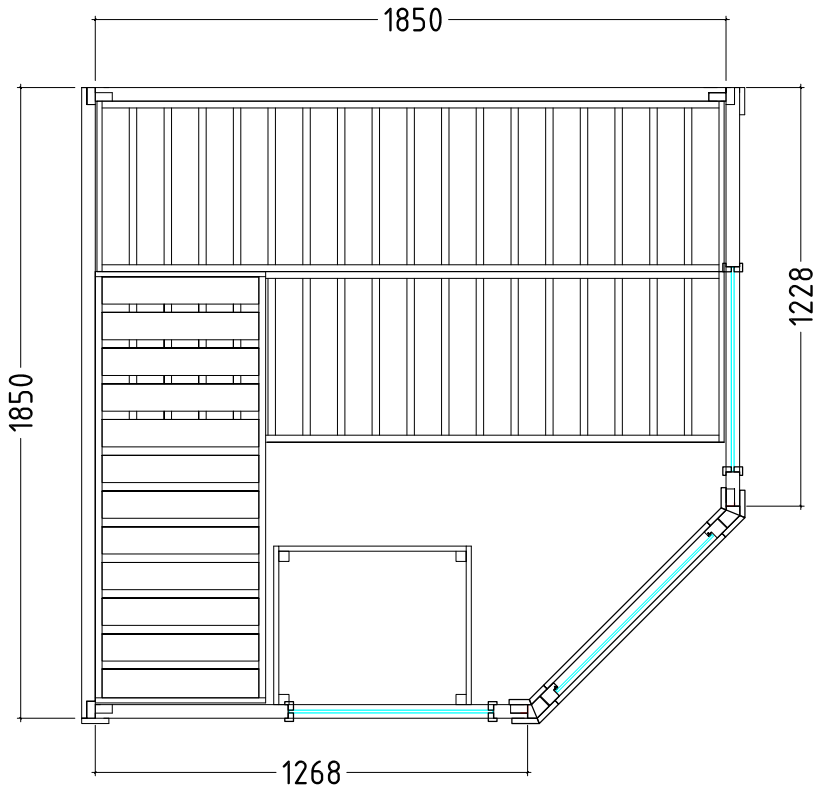

Solid wood sauna

Basic

CORNER

195 x 187 x 204 cm

INSTALLATION INSTRUCTIONS
English

EN



Table of Contents

1. Preparing for installation	3
1.1. Tools required	4
1.2. Maintenance and cleaning	5
1.3. Disposal	5
1.4. Basic Corner parts list	6
2. Cabin installation	8
2.1. Wall element assembly	8
2.2. Roof installation	13
2.3. Ventilation slit installation	15
2.4. Installing interior fittings	16
2.5. Installing accessories	18
2.6. Mounting the door frame	20
2.7. Mounting the cover slats	22
3. Floor plan	24

1. Preparing for installation

Read these assembly instructions carefully and keep them within reach when using the sauna so that you can look up product information at any time.



These assembly instructions can also be found in the downloads section of our website: www.sentiotec.com/downloads.

Important note:

- Before you begin work, check the parts list to ensure that all the individual parts have been delivered. If you discover any missing parts, notify your dealer within 14 days of receiving the sauna cabin.
- The room that the sauna is installed in must be dry and ensure an appropriate amount of air circulation.
- The floor must be level and even, preferably a stone or tiled floor.
- A minimum room height of 230 cm is required for the cabin installation work.
- A distance of at least 5 cm from the wall must be maintained.
- The inside of the wooden parts used must not be handled with any impregnating material.
- You need an assistant for the installation.
- Wood is a natural product that can swell, shrink or warp, despite good storage. For this reason, some force may be necessary during the installation.
- All screw fittings must be pre-drilled.

Attention!

The electrical connection may only be performed by a qualified electrician or similarly qualified person.

1.1. Tools required

- Hammer with a wooden head or a mallet
- Cordless screwdriver with bits for cross-head screws and Torx
- Roller tape measure
- Drill bits with a diameter of 3 mm, 10 mm, 20 - 30 mm (for sauna heater power cable)
- Spirit level
- 1.5 mm hexagonal socket wrench
- Utility knife
- Ladder



This symbol indicates tips and useful information



Pre-drill



Cut to real measurement with backsaw



Check the right angle:

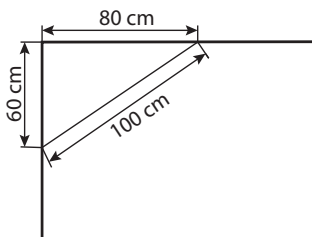

Handle glass with care: Special care must be taken with the edges of the glass – hardened glass can shatter into small pieces in the event of impact. Insert protective cushioning (e.g. cardboard box) under the edge of the glass.

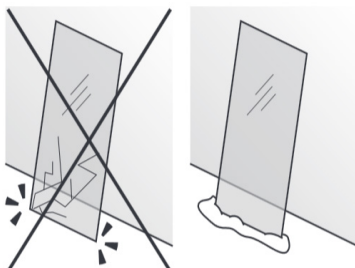

1.2. Maintenance and cleaning

- The sauna should be cleaned with a damp cloth. Only use warm water – no cleaning products.
- We recommend heating the cabin once a month if the sauna is not used for a long time.



Pitch pockets are not grounds for return, since they can always appear in spruce wood and the depth at which they lie cannot be detected during the sorting-out process.

If these are just under the surface, heat can cause them to soften and “bleed”.

The leaking pitch can be removed with a rag soaked in acetone. If only droplets of pitch occur, allow these to harden and then carefully scrape them off with a knife.

EN

1.3. Disposal



- Please dispose of packaging materials in accordance with the applicable disposal regulations.
- Used units contain reusable materials as well as hazardous substances. Therefore, do not dispose of your used unit with household waste, but rather do so in accordance with the locally applicable regulations.

1.4. Basic Corner parts list

No. of items	Name	Dimensions
Wall elements		
1	Lower rear wall element with ventilation aperture	185 x 102 x 4 cm
1	Lower left rear wall element	185 x 102 x 4 cm
1	Lower left side wall element	126.8 x 102 x 4 cm
1	Lower right side wall element	122.8 x 102 x 4 cm
2	Upper rear wall elements	185 x 108.8 x 4 cm
1	Upper left side wall element with glass	126.8 x 108.8 x 4 cm
1	Upper right side wall element with glass	122.8 x 108.8 x 4 cm
1	Door frame	204 x 88 x 4 cm
Roof elements		
1	Roof element	176 x 92 x 5.7 cm
1	Sloping roof element	176 x 92 x 5.7 cm
Support slats		
1	Roof support slat	181 x 4 x 4 cm
1	Roof support slat	169 x 4 x 4 cm
1	Roof support slat 1 x 45°	126.3 x 4 x 4 cm
1	Roof support slat 1 x 45°	118.3 x 4 x 4 cm
1	Roof support slats 2 x 45°	88.7 x 4 x 4 cm
2	Outer corner cover slats	204 x 8 x 1.5 cm
4	Outer corner cover slats 1 x 67°	204 x 8 x 1.5 cm
4	Inner corner cover slats 1 x 67°	204 x 6.5 x 1.5 cm
2	Outer door cover slats	69.3 x 8 x 1.5 cm
2	Inner door cover slats	67.7 x 8 x 1.5 cm
1	Inner roof cover slat	176 x 8 x 1.5 cm
1	Cable cover slat	194 x 4 x 3 cm
3	Bench support slats	50 x 4 x 4 cm
2	Bench support slat	100 x 4 x 4 cm

No. of items	Name	Dimensions
Interior fittings		
2	Benches	184 x 50 x 8 cm
1	Bench	126.5 x 50 x 8 cm
2	Heater grille strips	55 x 8 x 1.5 cm
4	Heater grille strips	46.5 x 8 x 1.5 cm
2	Heater grille strips	71 x 3 x 3 cm
2	Heater grille strips	39 x 3 x 3 cm
1	Headrest	30 x 28 cm
1	Lamp protection grille	52 x 24.5 x 2.7 cm
1	Ventilation slit	52 x 14 x 1.5 cm
Glass elements		
1	Door frame with glass door	178.3 x 73.5 x 4 cm
Accessories		
1	Door handle set	
1	Sauna lamp	
1	3 Silicon cables: 5 x 2.5 mm ²	
1	3 Silicon cables: 3 x 1.5 mm ²	
1	Installation material set	
1	Assembly instructions	

2. Cabin installation

Please refer to the floor plan on page 24.

2.1. Wall element assembly

Start with the lower part of the rear wall (ventilation slide) and the left rear wall. The lower parts can be identified by the projecting connecting strips.



Screw the rear wall to the side wall.
3 screws 5 x 80 mm



Repeat this with the right and left side wall.
6 screws 5 x 80 mm



Check that the wall elements are at right angles before screwing them together. Observe the tip on page 4.



Mounting the upper wall elements

When assembling the upper sections, again start with the rear wall. Make sure the connecting strips of the lower wall elements are flush.

EN

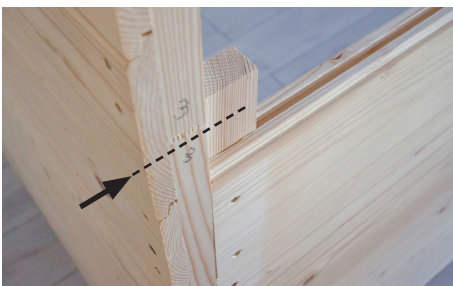

Screw both sides of the upper rear wall to the projecting strip of the lower rear wall. 2 screws 5 x 80 mm

When assembling the upper wall elements, make sure that they are flush with the connecting strips of the lower wall elements. Screw the upper wall elements together with three 5 x 80 mm screws for each wall element.



Note that each upper wall element must be screwed to the protruding strip of the lower wall element.

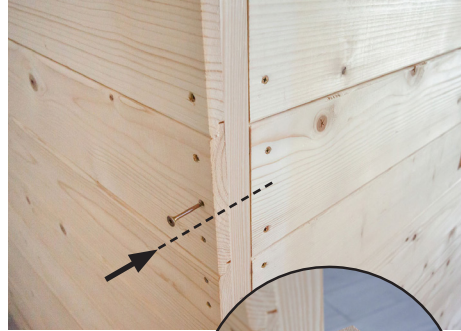



EN



Mounting the door frame

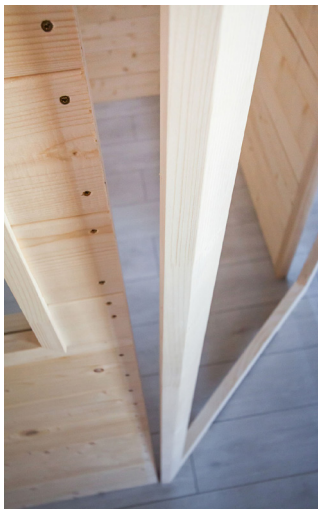

6 screws 5 x 100 mm

2.2. Roof installation

Roof support slats



EN

16 screws 4 x 70 mm



Roof elements



3 mm drill bit, 14 screws 5 x 80 mm



3 mm drill bit, 8 screws 3.5 x 40 mm

2.3. Ventilation slit installation



Symbol photo

3 mm drill bit, 4 screws 3.5 x 40 mm

2.4. Installing interior fittings

Bench support slats

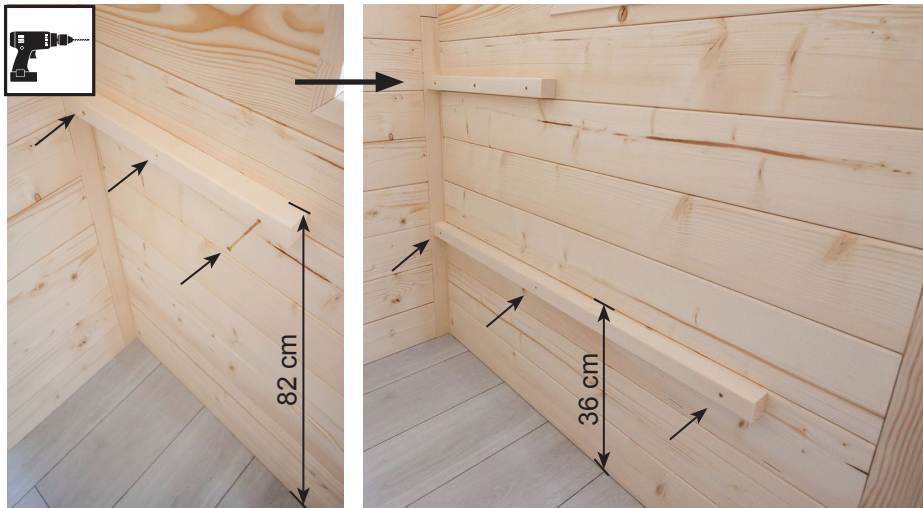

3 mm drill bit, 6 screws 5 x 70 mm

Repeat this on the opposite side and on the front wall as shown in the figure below.

9 screws 5 x 70 mm

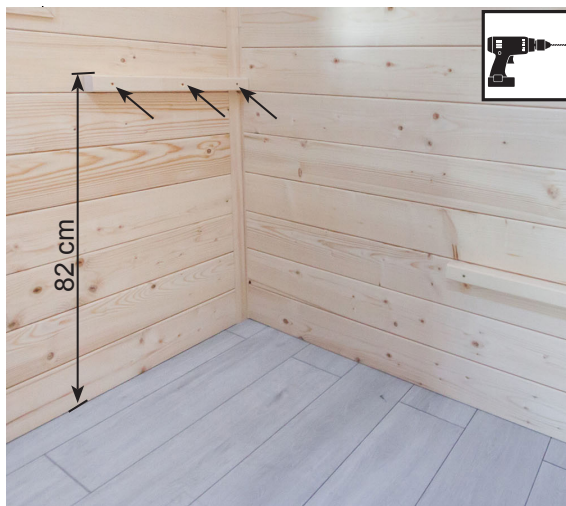
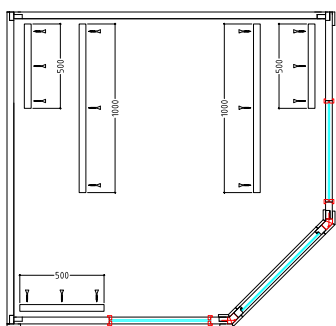

Bench



3 mm drill bit, 3 screws 5 x 50 mm



2.5. Installing accessories

Sauna lamp



Insert lamp
(not included in the scope of delivery)



3 mm drill bit, 2 screws



4 screws 3.5 x 40 mm

Heater protection grille and cable cover slat



Mount the cable cover slat and the sauna heater before fixing the heater protection grille to the wall.

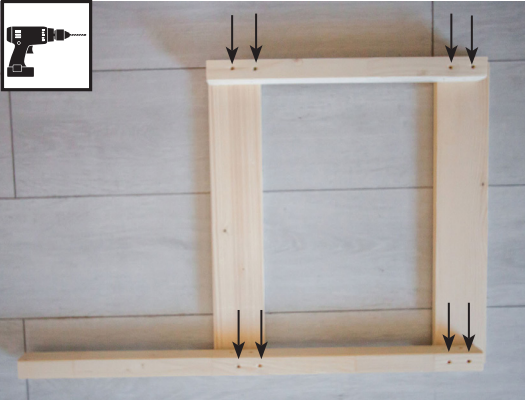

20 screws 3.5 x 40 mm



4 screws 3.5 x 40 mm

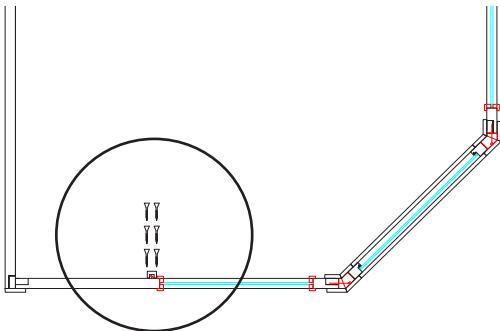

6 screws 4 x 60 mm



2.6. Mounting the door frame



6 screws 4 x 70 mm



Door handle and sleeve plate

Mount the sleeve plate level with the holes in the glass door.



2 screws 5 x 90 mm

2.7. Mounting the cover slats

Inner corner cover slats



3 mm drill bit, 32 screws 3.2 x 40 mm

Outer corner cover slats



3 mm drill bit, 48 screws 3.2 x 40 mm

Outer and inner corner cover slats



3 mm drill bit, 24 screws 3.2 x 40 mm

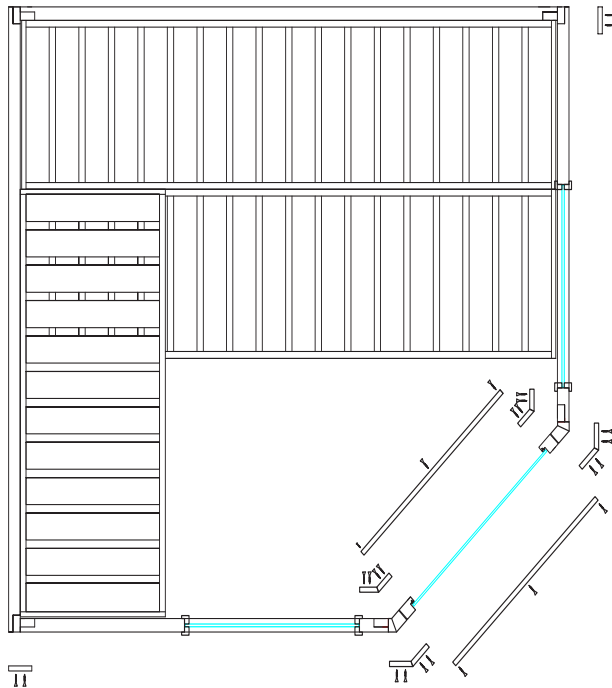

3. Floor plan

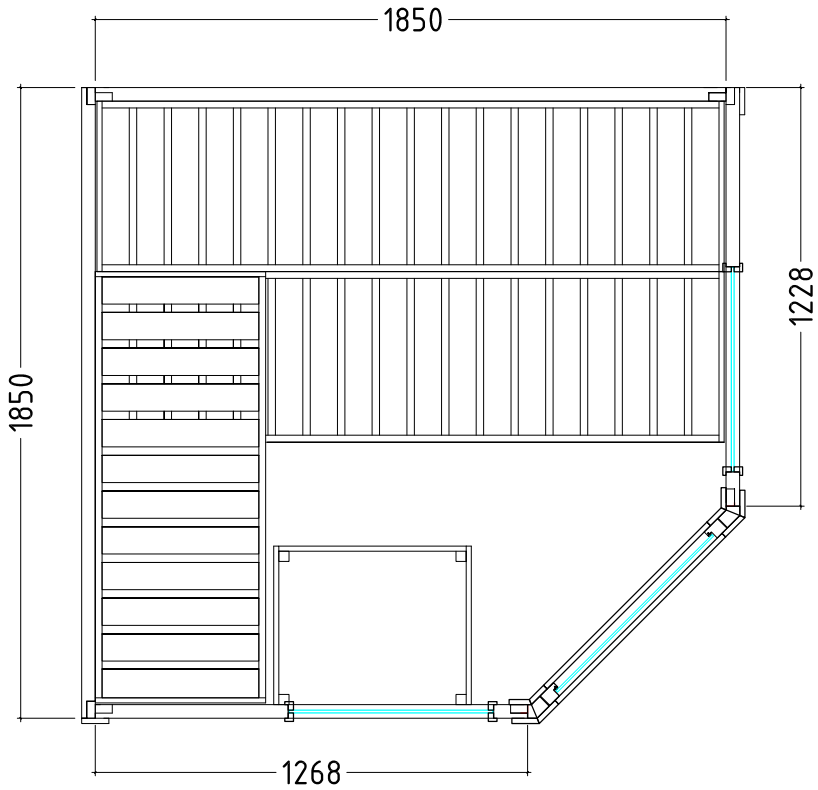

Sauna en bois massif

Basic

CORNER

195 x 187 x 204 cm

INSTRUCTIONS DE MONTAGE ET MODE D'EMPLOI
Français



FR

Table des matières

1. Préparation du montage	3
1.1. Outils requis	4
1.2. Entretien et nettoyage	5
1.3. Élimination	5
1.4. Nomenclature Basic Corner	6
2. Montage de la cabine	8
2.1. Montage des éléments muraux	8
2.2. Montage du toit	13
2.3. Montage du registre d'aération	15
2.4. Montage de l'équipement intérieur	16
2.5. Montage des accessoires	18
2.6. Montage du cadre de porte	20
2.7. Montage des baguettes de couverture	22
3. Plan	24

1. Préparation du montage

Lisez attentivement les présentes instructions de montage et gardez-les à proximité de l'appareil. Vous avez ainsi accès à tout moment aux informations sur le produit.



Vous trouverez également ces instructions de montage dans la rubrique de téléchargement de notre site Internet www.sentiotec.com/downloads.

Remarques importantes :

- Avant de commencer les travaux, vérifiez au moyen de la nomenclature si toutes les pièces ont bien été livrées. S'il devait s'avérer que des pièces manquent, informez votre revendeur dans les 14 jours suivant la réception de la cabine.
- La pièce dans laquelle la cabine de sauna va être montée doit être sèche et disposer d'une circulation suffisante de l'air.
- Le sol doit être horizontal et lisse, de préférence en pierre ou carrelage.
- Pour les travaux de montage de la cabine, la pièce doit faire au moins 230 cm de haut.
- Une distance d'au moins 5 cm avec le mur doit être respecté.
- Les pièces en bois prévues pour l'intérieur ne doivent pas être traitées avec un agent d'imprégnation.
- Une deuxième personne doit être disponible pour vous aider.
- Malgré un stockage correct, le bois est un produit naturel qui peut gonfler, se contracter ou se déformer. C'est pourquoi il peut arriver que vous ayez à appliquer de la force lors du montage.
- Tous les raccords vissés doivent être préalésés.

Attention !

Seul un électricien spécialisé ou une personne ayant une qualification similaire est habilité à procéder au raccordement électrique.

1.1. Outils requis

- Marteau et cales ou maillet en caoutchouc
- Visseuse électrique avec bits pour vis en croix et Torx
- Ruban de mesure
- Foret de 3 mm de diamètre, 10 mm, 20 - 30 mm (pour câble électrique poêle de sauna)
- Niveau à bulle
- Clé Allen 1,5 mm
- Couteau universel
- Échelle



Ce symbole désigne les conseils et indications utiles.



Préalésage



Sciage à la bonne longueur avec une scie fine



Contrôle de l'angle droit :

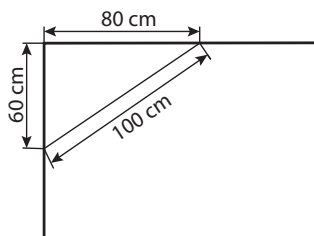

Manipulez le verre avec soin : Faire particulièrement attention avec les bords de la vitre ; en cas de choc, le verre trempé peut se briser en petits morceaux. Placez un rembourrage de protection (p. ex. un emballage en carton) sous le bord de la vitre.

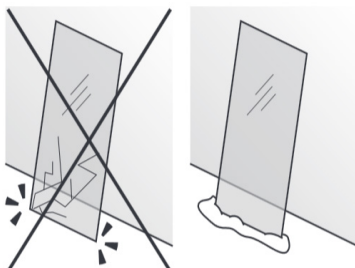

1.2. Entretien et nettoyage

- Le sauna doit être nettoyé au moyen d'un chiffon humide. N'utilisez que de l'eau chaude, pas de détergent.
- Si le sauna n'est pas utilisé pendant une période prolongée, nous recommandons de chauffer la cabine une fois par mois.



Les poches de résine ne constituent pas un motif de réclamation, en raison de leur présence régulière dans le bois d'épicéa et de l'impossibilité de déterminer leur profondeur lors de la sélection du bois.

Si elles se trouvent juste sous la surface, elles éclatent et s'écoulent quand elle sont exposées à la chaleur.

Retirez la résine écoulee à l'aide d'un chiffon imbibé d'acétone. Si vous constatez uniquement des gouttes de résine, attendez qu'elles aient durci, puis grattez-les avec précaution à l'aide d'un couteau.

1.3. Élimination



- Éliminez les matériaux d'emballage conformément aux directives en vigueur relatives à l'élimination.
- Les appareils usagés contiennent des matériaux recyclables, mais aussi des substances toxiques. Par conséquent, ne jetez en aucun cas votre appareil usagé avec les déchets ménagers. Éliminez-le conformément aux directives locales en vigueur.

1.4. Nomenclature Basic Corner

Az	Désignation	Dimensions
Éléments muraux		
1	Élément mural paroi arrière partie inférieure avec découpe d'aération	185 x 102 x 4 cm
1	Élément mural paroi arrière partie inférieure gauche	185 x 102 x 4 cm
1	Élément mural partie inférieure côté gauche	126,8 x 102 x 4 cm
1	Élément mural partie inférieure côté droit	122,8 x 102 x 4 cm
2	Éléments muraux paroi arrière partie supérieure	185 x 108,8 x 4 cm
1	Élément mural avec vitre partie supérieure gauche	126,8 x 108,8 x 4 cm
1	Élément mural avec vitre partie supérieure droite	122,8 x 108,8 x 4 cm
1	Cadre de porte	204 x 88 x 4 cm
Éléments du toit		
1	Élément de toit	176 x 92 x 5,7 cm
1	Élément de toit incliné	176 x 92 x 5,7 cm
Baguettes d'appui		
1	Baguette d'appui de toiture	181 x 4 x 4 cm
1	Baguette d'appui de toiture	169 x 4 x 4 cm
1	Baguettes d'appui de toiture 1 x 45°	126,3 x 4 x 4 cm
1	Baguettes d'appui de toiture 1 x 45°	118,3 x 4 x 4 cm
1	Baguette d'appui de toiture 2 x 45°	88,7 x 4 x 4 cm
2	Baguettes de couverture d'angles à l'extérieur	204 x 8 x 1,5 cm
4	Baguettes de couverture d'angles à l'extérieur 1 x 67°	204 x 8 x 1,5 cm
4	Baguettes de couverture d'angles à l'intérieur 1 x 67°	204 x 6,5 x 1,5 cm
2	Baguettes de couverture de portes à l'extérieur	69,3 x 8 x 1,5 cm
2	Baguettes de couverture de portes à l'intérieur	67,7 x 8 x 1,5 cm
1	Baguette couvre-joint de toiture à l'intérieur	176 x 8 x 1,5 cm
1	Baguette de couverture de câbles	194 x 4 x 3 cm
3	Baguettes d'appui de banc	50 x 4 x 4 cm
2	Baguette d'appui de banc	100 x 4 x 4 cm

Az Désignation	Dimensions
Équipement intérieur	
2 Bancs	184 x 50 x 8 cm
1 Banc	126,5 x 50 x 8 cm
2 Barres de grille de protection de poêle	55 x 8 x 1,5 cm
4 Barres de grille de protection de poêle	46,5 x 8 x 1,5 cm
2 Barres de grille de protection de poêle	71 x 3 x 3 cm
2 Barres de grille de protection de poêle	39 x 3 x 3 cm
1 Appuie-tête	30 x 28 cm
1 Grille de protection de lampe	52 x 24,5 x 2,7 cm
1 Registres d'aération	52 x 14 x 1,5 cm
Éléments en verre	
1 Cadre de porte avec porte en verre	178,3 x 73,5 x 4 cm
Accessoires	
1 Kit de poignées de portes	
1 Éclairage de sauna	
1 3 mètres linéaires Câble silicone 5 x 2,5 mm ²	
1 3 mètres linéaires Câble silicone 3 x 1,5 mm ²	
1 Kit de matériel de montage	
1 Instructions de montage	

2. Montage de la cabine

Référez-vous au plan page 24.

2.1. Montage des éléments muraux

Commencez par la partie inférieure de la paroi arrière (registre d'aération) et la paroi arrière gauche. Les parties inférieures sont reconnaissables aux barres de raccordement saillantes.



Vissez la paroi arrière à la paroi latérale.
3 vis 5 x 80 mm



Répétez cette opération avec les parois latérales droite et gauche.
6 vis 5 x 80 mm



Contrôlez les angles droits avant de visser d'autres éléments muraux.
Consultez le conseil page 4.



Montage de la partie supérieure des éléments muraux

Pour le montage des parties supérieures, commencez à nouveau avec la paroi arrière. Veillez à ce que le raccordement soit affleurant avec les barres de raccordement des éléments muraux inférieurs.

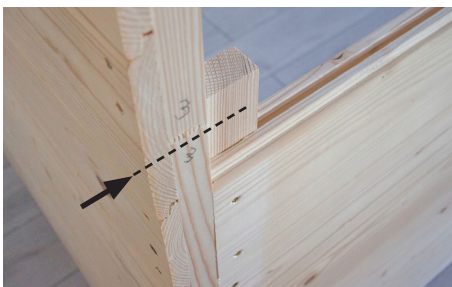
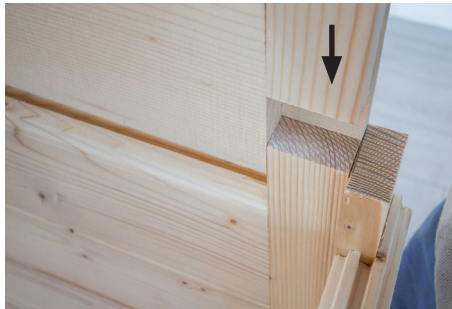

Vissez le panneau arrière supérieur des deux côtés sur la barre saillante de la paroi arrière inférieure. 2 vis 5 x 80 mm

Lors du montage des éléments muraux supérieurs, veillez au bon alignement avec les barres de raccordement des éléments muraux inférieurs. Vissez les éléments muraux supérieurs ensemble (par élément mural 3 vis 5 x 80 mm)



Notez que l'élément mural supérieur doit être vissé sur la barre saillante de l'élément mural inférieur correspondant.

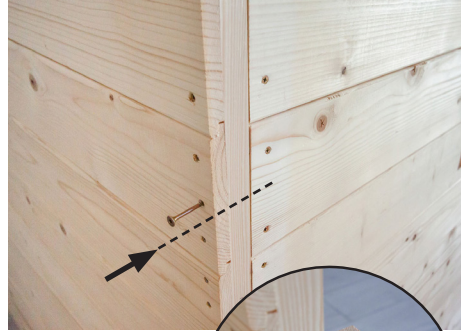



FR



Montage du cadre de porte

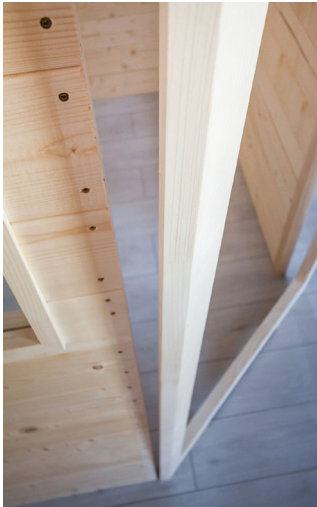

6 vis 5 x 100 mm

2.2. Montage du toit

Baguettes d'appui de toit



16 vis 4 x 70 mm



Éléments du toit



Foret de 3 mm, 14 vis 5 x 80 mm



Foret de 3 mm, 8 vis 3,5 x 40 mm

2.3. Montage du registre d'aération

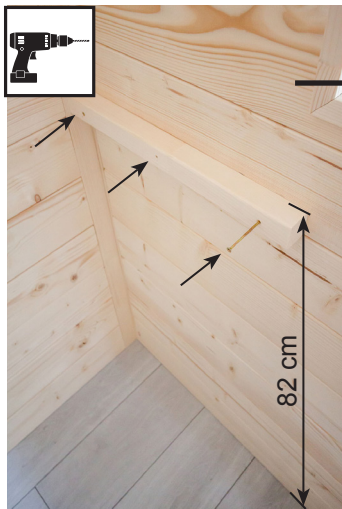

Photo symbolique

Foret de 3 mm, 4 vis 3,5 x 40 mm

2.4. Montage de l'équipement intérieur

Baguettes d'appui de banc



Foret de 3 mm, 6 vis 5 x 70 mm

Répétez l'opération sur le côté opposé et sur la paroi avant, comme indiqué sur la figure ci-dessous.

9 vis 5 x 70 mm

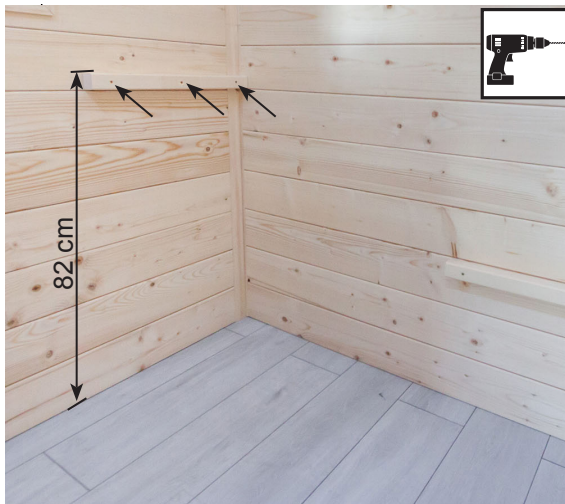
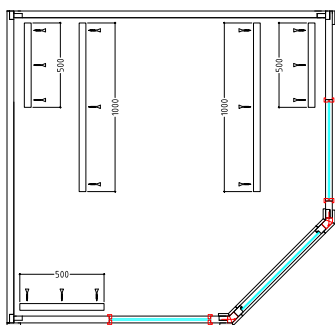

Banc



FR

Foret de 3 mm, 3 vis 5 x 50 mm



2.5. Montage des accessoires

Éclairage de sauna



Mise en place des ampoules
(non compris dans la livraison)



Foret de 3 mm, 2 vis



4 vis 3,5 x 40 mm

Grille de protection de poêle et baguette de couverture de câbles

 Avant de fixer la grille de protection du poêle au mur, montez la baguette de couverture de câbles et le poêle de sauna.

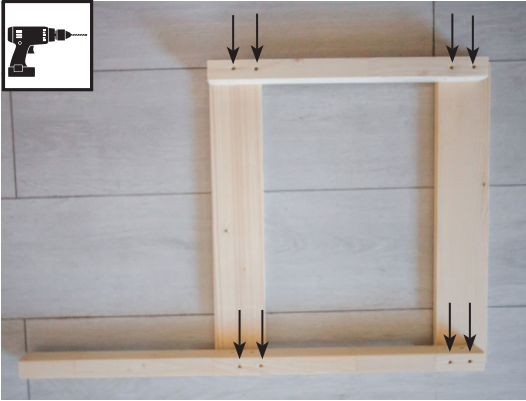

20 vis 3,5 x 40 mm



4 vis 3,5 x 40 mm



FR

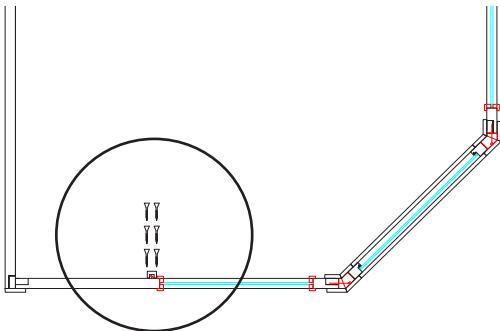

6 vis 4 x 60 mm



2.6. Montage du cadre de porte



6 vis 4 x 70 mm



Poignée de porte et tôle extérieure

Montez la tôle extérieure à la hauteur des trous dans la porte en verre



2 vis 5 x 90 mm

2.7. Montage des baguettes de couverture

Baguettes de couverture d'angles à l'intérieur



Foret de 3 mm, 32 vis 3,2 x 40 mm

Baguettes de couverture d'angles à l'extérieur



Foret de 3 mm, 48 vis 3,2 x 40 mm

Baguettes de couverture de portes à l'intérieur et à l'extérieur



Foret de 3 mm, 24 vis 3,2 x 40 mm

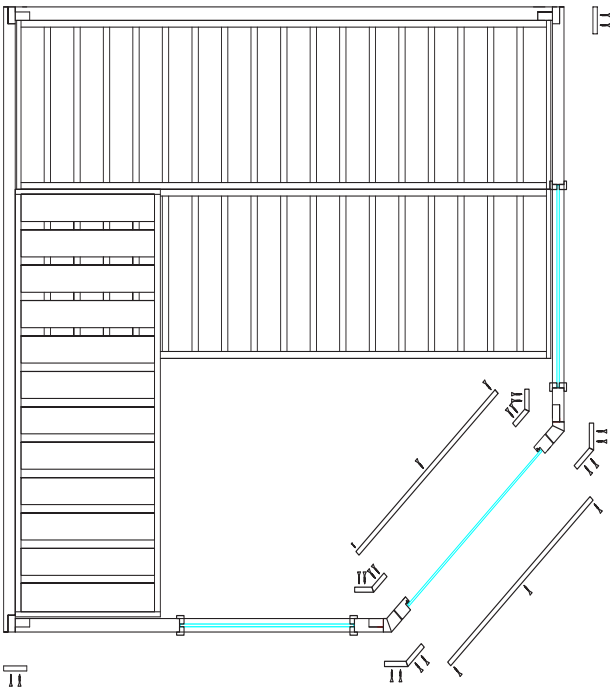

3. Plan

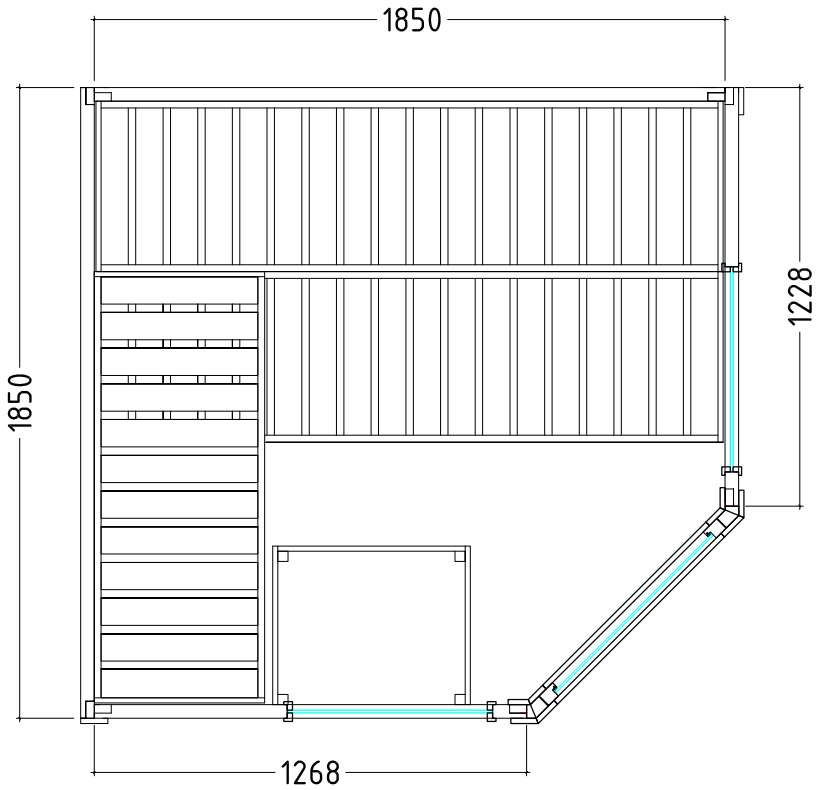

Sauna in legno massiccio

Basic

CORNER

195 x 187 x 204 cm

ISTRUZIONI DI MONTAGGIO E PER L'USO
Italiano



IT

Indice

1. Preparazione per il montaggio	3
1.1. Attrezzi necessari	4
1.2. Manutenzione e pulizia	5
1.3. Smaltimento	5
1.4. Elenco delle parti Basic Corner	6
2. Montaggio della cabina	8
2.1. Montaggio degli elementi parete	8
2.2. Montaggio del tetto	13
2.3. Montaggio del pannello scorrevole di aerazione	15
2.4. Montaggio dell'allestimento interno	16
2.5. Montaggio accessori	18
2.6. Montaggio del telaio a contatto porta	20
2.7. Montaggio delle strisce di copertura	22
3. Pianta	24

1. Preparazione per il montaggio

Leggere con attenzione le presenti istruzioni di montaggio e conservarle in prossimità della sauna. In questo modo è possibile controllare in qualsiasi momento le informazioni relative al prodotto.



Le presenti istruzioni di montaggio si trovano anche nella sezione download del nostro sito web all'indirizzo: www.sentiotec.com/downloads.

Indicazioni importanti:

- Prima di iniziare i lavori, controllare in base all'elenco dei pezzi se tutti i singoli componenti sono stati effettivamente forniti. Se eccezionalmente dovessero mancare dei singoli componenti, contattare il proprio fornitore entro 14 giorni dal ricevimento della cabina.
- L'ambiente in cui la cabina della sauna viene montata deve essere asciutto e garantire la circolazione dell'aria richiesta.
- Il pavimento deve essere orizzontale e uniforme, preferibilmente in pietra o piastrelle.
- Per i lavori di montaggio della cabina è necessaria un'altezza minima libera di 230 cm.
- Mantenere una distanza minima dalle pareti di 5 cm.
- I componenti in legno da utilizzare all'interno non devono essere trattati con impregnante.
- Per il montaggio è richiesto l'aiuto di una seconda persona.
- Il legno è un prodotto naturale che può gonfiarsi, ritirarsi o deformarsi anche se immagazzinato correttamente. In fase di montaggio potrebbe quindi essere necessario applicare una certa forza.
- Tutte le connessioni a vite devono essere preforate.

Attenzione!

Il collegamento elettrico deve essere eseguito da elettricisti specializzati o da persone con una qualifica simile.

1.1. Attrezzi necessari

- Martello e pezzo di legno oppure martello in gomma
- Avvitatore elettrico con punte per viti con testa a croce e viti Torx
- Metro a nastro avvolgibile
- Punta per trapano da 3 mm, 10 mm, 20-30 mm (per cavo elettrico della stufa per sauna)
- Livella a bolla
- Chiave a brugola da 1,5 mm
- Cutter
- Scala



Questo simbolo indica consigli e indicazioni utili



Preforatura



Taglio alla lunghezza effettiva mediante seghetto



Verifica dell'ortogonalità:

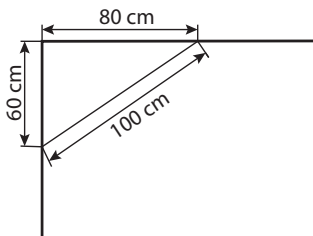

Maneggiare il vetro con cura: particolare attenzione deve essere prestata ai bordi del vetro - il vetro temprato può frantumarsi in piccoli pezzi in caso di impatto. Inserire un cuscino di protezione (ad es: scatola di cartone) sotto il bordo del vetro.

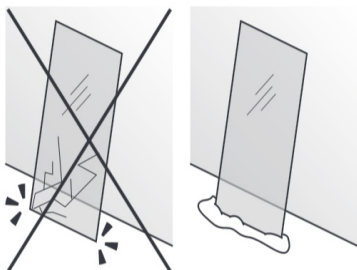

1.2. Manutenzione e pulizia

- La sauna deve essere pulita con un panno umido. Utilizzare solo acqua calda senza detersivi.
- Se la sauna non viene utilizzata per un tempo prolungato, si consiglia di riscaldare la cabina una volta al mese.



Le tasche di resina non sono motivo di reclamo perché nel legno di abete rosso sono sempre presenti e durante la selezione non è possibile rilevare a quale profondità si trovino.

Quando sono appena al di sotto della superficie, con lo sviluppo del calore si rompono e possono “essudare”.

Rimuovere la resina fuoriuscita con un panno imbevuto di acetone. Se sono presenti solo gocce di resina, lasciarle indurire e poi raschiarle con cautela usando un coltello.

1.3. Smaltimento



- Smaltire i materiali dell’imballaggio conformemente alle normative sullo smaltimento vigenti.
- I vecchi apparecchi contengono materiali riciclabili ma anche sostanze dannose. Non gettare mai l’apparecchio usato insieme ai rifiuti non riciclabili, bensì smaltirlo in conformità alle norme vigenti a livello locale.

1.4. Elenco delle parti Basic Corner

Pz.	Denominazione	Dimensioni
Elementi parete		
1	Elemento parete pannello posteriore inferiore con foro di ventilazione	185 x 102 x 4 cm
1	Elemento parete pannello posteriore inferiore a sinistra	185 x 102 x 4 cm
1	Elemento parete lato sinistro inferiore	126,8 x 102 x 4 cm
1	Elemento parete lato destro inferiore	122,8 x 102 x 4 cm
2	Elementi parete pannello posteriore superiore	185 x 108,8 x 4 cm
1	Elemento parete con vetro lato sinistro superiore	126,8 x 108,8 x 4 cm
1	Elemento parete con vetro lato destro superiore	122,8 x 108,8 x 4 cm
1	Telaio della porta	204 x 88 x 4 cm
Elementi del tetto		
1	Elemento tetto	176 x 92 x 5,7 cm
1	Elemento tetto inclinato	176 x 92 x 5,7 cm
Listelli di supporto		
1	Listello di supporto tetto	181 x 4 x 4 cm
1	Listello di supporto tetto	169 x 4 x 4 cm
1	Listelli di supporto del tetto 1 x 45°	126,3 x 4 x 4 cm
1	Listelli di supporto del tetto 1 x 45°	118,3 x 4 x 4 cm
1	Listello di supporto del tetto 2 x 45°	88,7 x 4 x 4 cm
2	Strisce di copertura angoli esterne	204 x 8 x 1,5 cm
4	Strisce di copertura angoli esterne 1 x 67°	204 x 8 x 1,5 cm
4	Strisce di copertura angoli interne 1 x 67°	204 x 6,5 x 1,5 cm
2	Strisce di copertura esterne porta	69,3 x 8 x 1,5 cm
2	Strisce di copertura interne porta	67,7 x 8 x 1,5 cm
1	Striscia di copertura interna tetto	176 x 8 x 1,5 cm
1	Piastra copricavi	194 x 4 x 3 cm
3	Listelli di supporto panca	50 x 4 x 4 cm
2	Listello di supporto panca	100 x 4 x 4 cm

Pz.	Denominazione	Dimensioni
Allestimento interno		
2	Panche	184 x 50 x 8 cm
1	Panca	126,5 x 50 x 8 cm
2	Strisce griglia di protezione stufa	55 x 8 x 1,5 cm
4	Strisce griglia di protezione stufa	46,5 x 8 x 1,5 cm
2	Strisce griglia di protezione stufa	71 x 3 x 3 cm
2	Strisce griglia di protezione stufa	39 x 3 x 3 cm
1	Poggiatesta	30 x 28 cm
1	Griglia di protezione lampada	52 x 24,5 x 2,7 cm
1	Pannello scorrevole di aerazione	52 x 14 x 1,5 cm
Elementi in vetro		
1	Telaio a contatto porta con porta in vetro	178,3 x 73,5 x 4 cm
Accessori		
1	Set di maniglie	
1	Lampada	
1	Cavo in silicone da 3 metri 5 x 2,5 mm ²	
1	Cavo in silicone da 3 metri 3 x 1,5 mm ²	
1	Set di materiale di montaggio	
1	Istruzioni di montaggio	

2. Montaggio della cabina

Fare riferimento alla planimetria a pagina 23.

2.1. Montaggio degli elementi parete

Iniziare con la parte inferiore del pannello posteriore (slitta di ventilazione) e con il pannello posteriore a sinistra. Le parti inferiori sono riconoscibili dai listelli di collegamento sporgenti.



Avvitare il pannello posteriore al pannello laterale.
3 viti 5 x 80 mm



Ripetere l'operazione con i pannelli laterali destro e sinistro.
6 viti 5 x 80 mm



Verificare l'ortogonalità degli elementi parete prima di avvitarli tra loro.
Seguire l'indicazione a pagina 4.



Montaggio di elementi parete superiori

Durante il montaggio delle parti superiori, ricominciare dal pannello posteriore.
Accertarsi del collegamento a filo con i listelli di collegamento degli elementi parete inferiori.

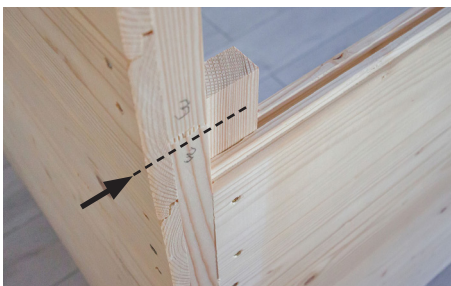
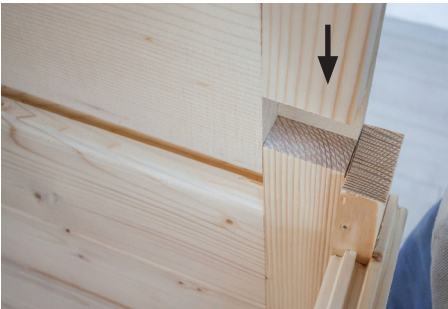

Avvitare il pannello posteriore superiore su entrambi i lati alla striscia sporgente del pannello posteriore inferiore. 2 viti 5 x 80 mm

Quando si installano gli elementi parete superiori, accertarsi che siano a filo con i listelli di collegamento degli elementi parete inferiori. Avvitare gli elementi parete superiori, con 3 viti 5 x 80 mm per ogni elemento parete



Tenere presente che l'elemento parete superiore deve essere avvitato alla striscia sporgente dell'elemento parete inferiore.

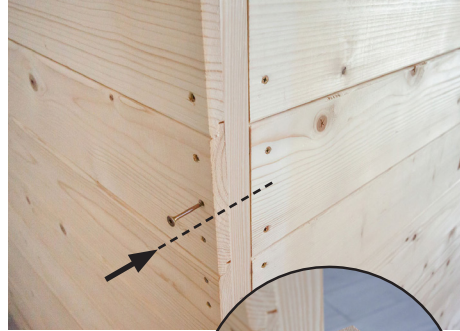



Montaggio del telaio della porta

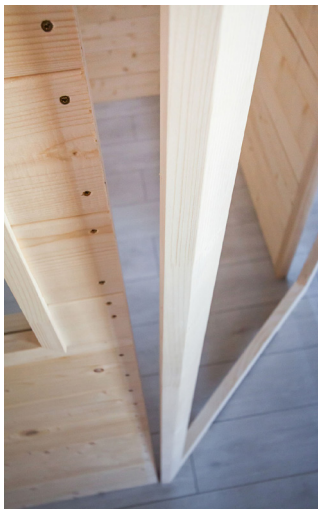

6 viti 5 x 100 mm

2.2. Montaggio del tetto

Listelli di supporto del tetto

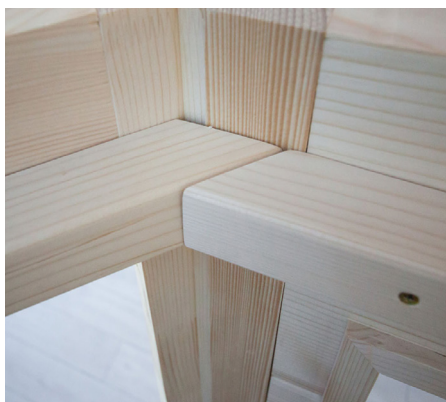

16 viti 4 x 70 mm



Elementi del tetto



Punta per trapano da 3 mm, 14 viti 5 x 80 mm



Punta per trapano da 3 mm, 8 viti 3,5 x 40 mm

2.3. Montaggio del pannello scorrevole di aerazione



IT

Punta per trapano da 3 mm, 4 viti 3,5 x 40 mm

2.4. Montaggio dell'allestimento interno

Listelli di supporto panca

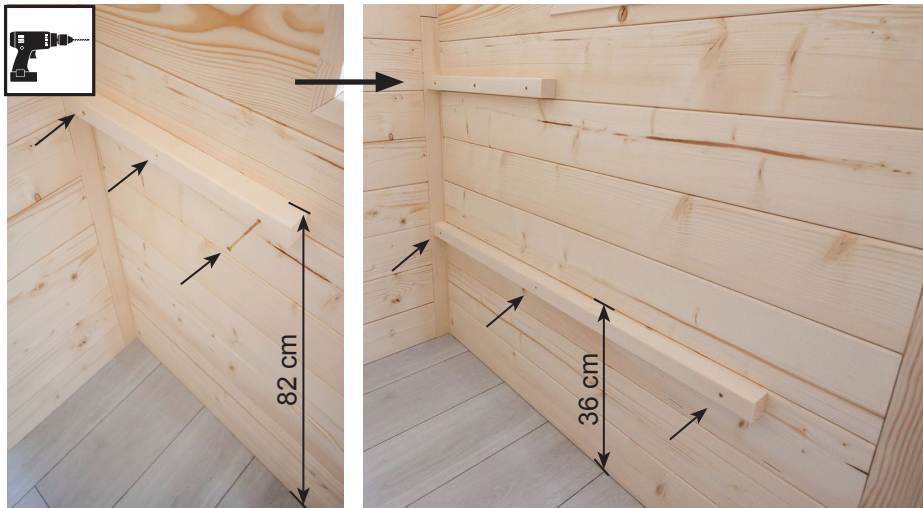

Punta per trapano da 3 mm, 6 viti 5 x 70 mm

Ripetere l'operazione sul lato opposto e sul pannello anteriore come mostrato nella figura seguente.

9 viti 5 x 70 mm

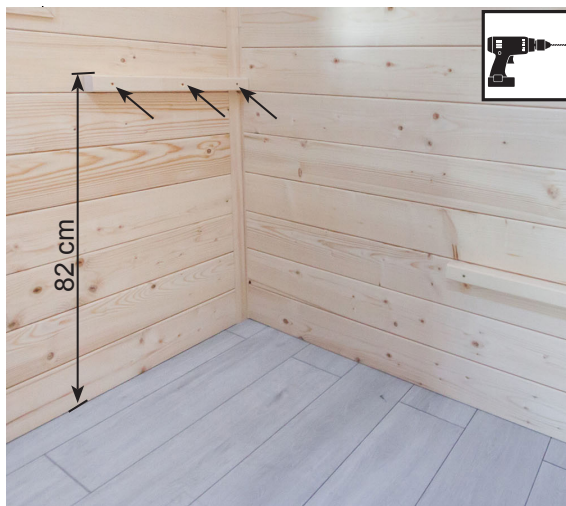
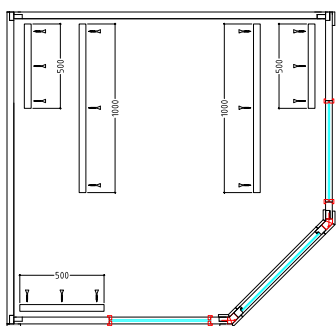

Panca



IT

Punta per trapano da 3 mm, 3 viti 5 x 50 mm



2.5. Montaggio accessori

Lampada



Inserire una lampadina
(non compresa nella fornitura)



Punta per trapano da 3 mm, 2 viti



4 viti 3,5 x 40 mm

Griglia di protezione stufa e piastra copricavi



Montare la piastra copricavi e la stufa per sauna prima di fissare la griglia di protezione stufa alla parete.

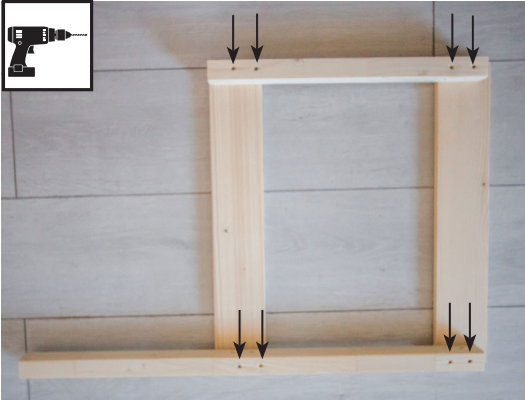

20 viti 3,5 x 40 mm



4 viti 3,5 x 40 mm



IT

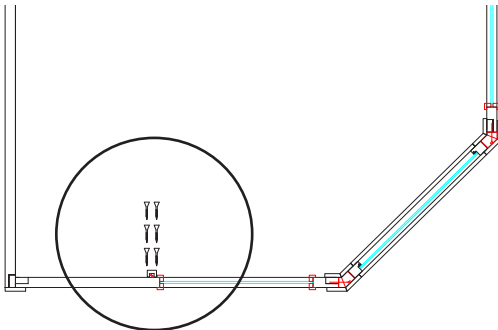

6 viti 4 x 60 mm



2.6. Montaggio del telaio a contatto porta



6 viti 4 x 70 mm

Maniglia porta e lamierino di battuta

Montare il lamierino di battuta all'altezza dei fori della porta in vetro.



2 viti 5 x 90 mm

2.7. Montaggio delle strisce di copertura

Strisce di copertura angoli interne



Punta per trapano da 3 mm, 32 viti 3,2 x 40 mm

Strisce di copertura angoli esterne



Punta per trapano da 3 mm, 48 viti 3,2 x 40 mm

Strisce di copertura porta esterne e interne



Punta per trapano da 3 mm, 24 viti 3,2 x 40 mm

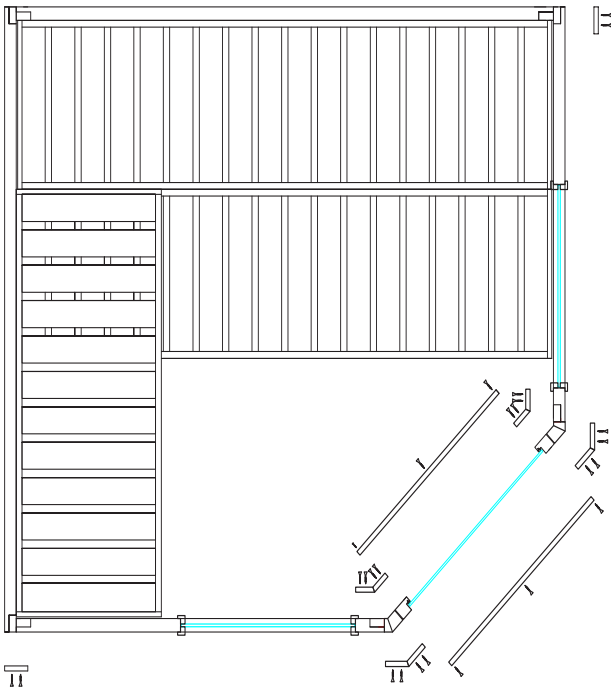

3. Pianta

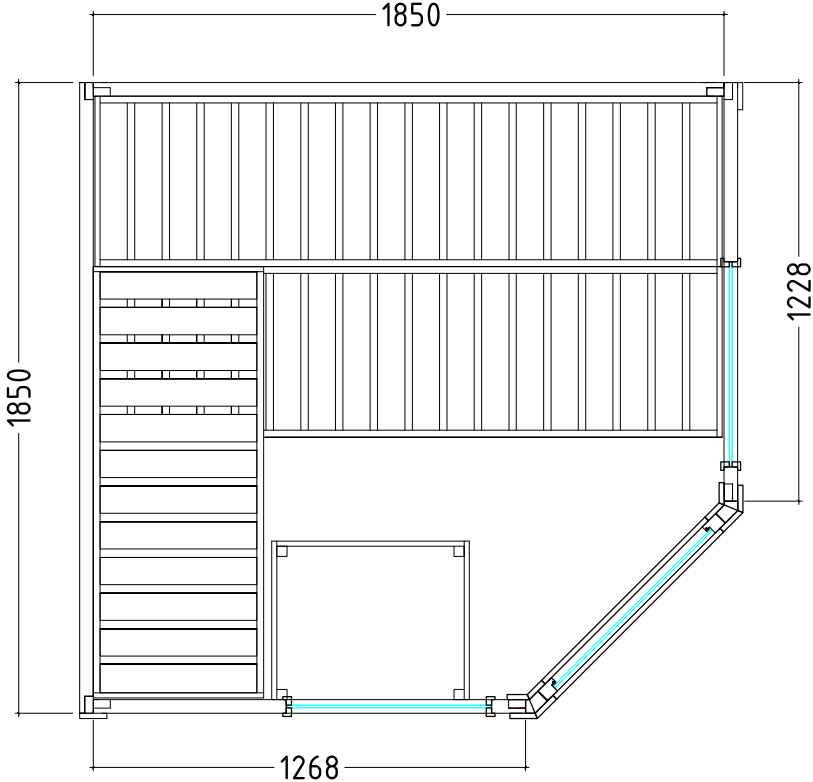

Sauna z litego drewna

Basic

CORNER

195 x 187 x 204 cm

INSTRUKCJA MONTAŻU
Polski

PL



Spis treści

1. Przygotowanie montażu	3
1.1. Wymagane narzędzia	4
1.2. Konserwacja i czyszczenie	5
1.3. Utylizacja	5
1.4. Wykaz części Basic Corner	6
2. Montaż kabiny	8
2.1. Montaż elementów ściennych	8
2.2. Montaż dachu	13
2.3. Montaż zasuwki do wentylacji	15
2.4. Montaż urządzenia wnętrza	16
2.5. Montaż akcesoriów	18
2.6. Montaż ościeżnicy drzwi	20
2.7. Montaż listew maskujących	22
3. Rzut	24

1. Przygotowanie montażu

Przeczytaj uważnie niniejszą instrukcję montażu. Przechowuj ją w pobliżu sauny. Dzięki temu możliwe będzie w każdej chwili przeczytanie informacji o produkcie.



Niniejsza instrukcja montażu jest również dostępna do pobrania na naszej stronie internetowej www.sentiotec.com/downloads.

Ważne wskazówki:

- Przed rozpoczęciem pracy na podstawie listy części sprawdź, czy wszystkie części zostały faktycznie dostarczone. Jeśli brakuje którejkolwiek z części, poinformuj sprzedawcę najpóźniej 14 dni po otrzymaniu kabiny.
- Pomieszczenie, w którym zostanie zamontowana kabina sauny, musi być suche i zapewniać odpowiednią cyrkulację powietrza.
- Podłoga musi być pozioma i równa, preferowana podłoga kamienna lub podłoga wyłożona płytkami.
- Aby zamontować kabinę, pomieszczenie musi mieć minimalną wysokość wynoszącą 230 cm.
- Musi zostać zachowana odległość od ściany wynosząca co najmniej 5 cm.
- Części z drewna, które mają być użyte wewnątrz, nie mogą być lakierowane środkami impregnującymi.
- Do montażu potrzebna jest druga osoba.
- Drewno jest naturalnym produktem, który pomimo dobrego przechowywania może pęcznieć, kurczyć się lub wykrzywiać. Z tego powodu podczas montażu może być konieczne użycie siły.
- Wszystkie połączenia gwintowane muszą być nawiercone.

Uwaga!

Podłączenie elektryczne może wykonywać tylko wykwalifikowany elektryk lub osoba posiadająca podobne kwalifikacje.

1.1. Wymagane narzędzia

- Młotek i przekładka z drewna lub młotek gumowy
- Wkrętarka akumulatorowa z bitami do wkrętów krzyżowych i Torx
- Taśma miernicza
- Wiertło o średnicy 3 mm, 10 mm, 20 - 30 mm
(do przewodu zasilającego piec sauny)
- Poziomica
- Klucz imbusowy 1,5 mm
- Nóż uniwersalny
- Drabina



Ten symbol oznacza rady i przydatne wskazówki



Wstępne wiercenie



Cięcie na miarę za pomocą piły



Sprawdzenie kąta prostego:

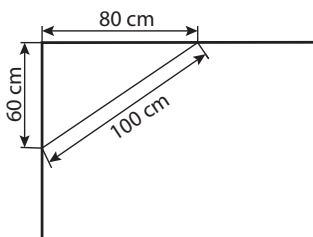

Ostrożne obchodzenie się ze szkłem: Szczególnie ostrożnie należy postępować w przypadku krawędzi szkła – szkło hartowane może w przypadku uderzenia rozprysnąć się na drobne okruchy. Podłożyć osłonę zabezpieczającą (np.: karton opakowaniowy) pod krawędź szkła.

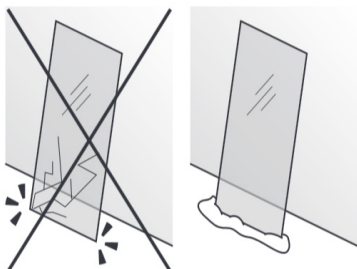

1.2. Konserwacja i czyszczenie

- Sauna powinna być czyszczona wilgotną ściereczką. Używaj tylko ciepłej wody – żadnych detergentów.
- Jeśli sauna nie jest używana przez dłuższy czas, zaleca się rozgrzewanie kabiny raz w miesiącu.



Pęcherze żywiczne nie są podstawą do reklamacji. W drewnie świerkowym często zdarzają się pęcherze żywiczne i podczas jego sortowania nie można ocenić, na jakiej głębokości się one znajdują.

Jeśli znajdują się one tuż pod powierzchnią, przy wzroście temperatury mogą pękać i wypływać.

Żywicę, która wypłynęła, można usunąć za pomocą szmatki zamoczonej w acetonie. Jeśli powstaną tylko kropelki żywicy, należy poczekać, aż stwardnieją, a następnie ostrożnie zeszkrobać nożem.

PL

1.3. Utylizacja



- Utylizuj materiały opakowaniowe zgodnie z obowiązującymi odpowiednimi dyrektywami.
- Zużyte urządzenia zawierają materiały możliwe do powtórnego przetworzenia jak również szkodliwe substancje. Dlatego nie umieszczaj ich w pojemniku na urządzenia nienadające się do powtórnego przetworzenia, lecz utylizuj je zgodnie z lokalnymi przepisami.

1.4. Wykaz części Basic Corner

Ilość	Nazwa	Wymiar
Elementy ścienne		
1	Element ścienny tylnej ścianki, dolny z otworem wentylacyjnym	185 x 102 x 4 cm
1	Element ścienny tylnej ścianki, lewy, dolny	185 x 102 x 4 cm
1	Element ścienny, lewy, boczny, dolny	126,8 x 102 x 4 cm
1	Element ścienny, prawy, boczny, dolny	122,8 x 102 x 4 cm
2	Elementy ścienne tylnej ścianki, górne	185 x 108,8 x 4 cm
1	Element ścienny ze szkłem, strona lewa, górna	126,8 x 108,8 x 4 cm
1	Element ścienny ze szkłem, strona prawa, górna	122,8 x 108,8 x 4 cm
1	Odrzwia	204 x 88 x 4 cm
Elementy dachowe		
1	Element dachowy	176 x 92 x 5,7 cm
1	Element dachowy, ukośny	176 x 92 x 5,7 cm
Listwy nakładane		
1	Listwa podporowa dachu	181 x 4 x 4 cm
1	Listwa podporowa dachu	169 x 4 x 4 cm
1	Listwy podporowe dachu 1 x 45°	126,3 x 4 x 4 cm
1	Listwy podporowe dachu 1 x 45°	118,3 x 4 x 4 cm
1	Listwa podporowa dachu 2 x 45°	88,7 x 4 x 4 cm
2	Listwy maskujące zewnętrzne, narożne	204 x 8 x 1,5 cm
4	Listwy maskujące zewnętrzne, narożne 1 x 67°	204 x 8 x 1,5 cm
4	Listwy maskujące wewnętrzne 1 x 67°	204 x 6,5 x 1,5 cm
2	Listwy maskujące zewnętrzne drzwi	69,3 x 8 x 1,5 cm
2	Listwy maskujące wewnętrzne drzwi	67,7 x 8 x 1,5 cm
1	Listwa maskująca dachu wewnętrzną	176 x 8 x 1,5 cm
1	Listwa maskująca kable	194 x 4 x 3 cm
3	Listy nakładane na ławkę	50 x 4 x 4 cm
2	Listwa podporowa ławki	100 x 4 x 4 cm

Ilość	Nazwa	Wymiar
Urządzenie wnętrza		
2	Ławki	184 x 50 x 8 cm
1	Ławka	126,5 x 50 x 8 cm
2	Listwy kraty ochronnej pieca	55 x 8 x 1,5 cm
4	Listwy kraty ochronnej pieca	46,5 x 8 x 1,5 cm
2	Listwy kraty ochronnej pieca	71 x 3 x 3 cm
2	Listwy kraty ochronnej pieca	39 x 3 x 3 cm
1	Zagłówek	30 x 28 cm
1	Krata ochronna lampy	52 x 24,5 x 2,7 cm
1	Zasuwka do wentylacji	52 x 14 x 1,5 cm
Elementy szklane		
1	Rama drzwi z drzwiami szklanymi	178,3 x 73,5 x 4 cm
Akcesoria		
1	Zestaw klamki do drzwi	
1	Lampa do sauny	
1	3 mb Przewód silikonowy 5 x 2,5 mm ²	
1	3 mb Przewód silikonowy 3 x 1,5 mm ²	
1	Zestaw materiałów montażowych	
1	Instrukcja montażu	

2. Montaż kabiny

Należy przy tym przestrzegać rzutu poziomego na str. 24.

2.1. Montaż elementów ściennych

Należy rozpocząć od dolnej części tylnej ścianki (zasuwka do wentylacji) oraz tylnej ścianki z lewej strony. Części dolne można rozpoznać po wystających listwach łączących.

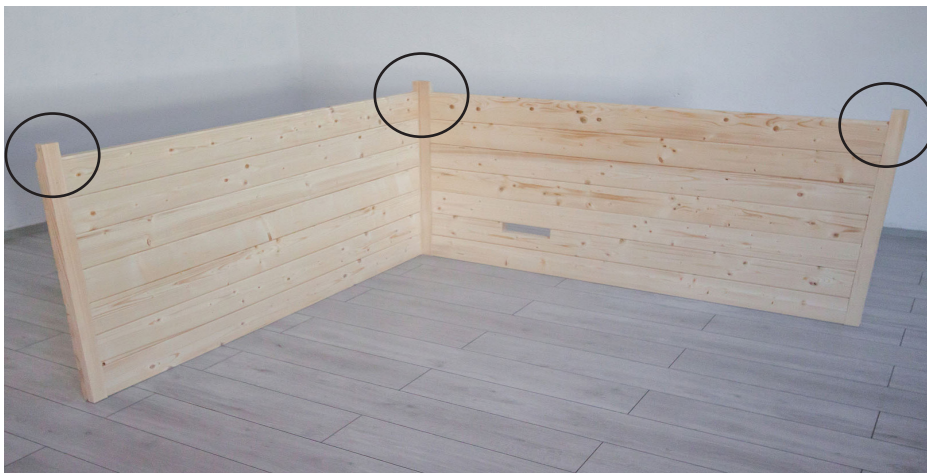

Skręć śrubami tylną ściankę ze ścianką boczną.
Śruby 5 x 80 mm – 3 szt.



Powtórzyć tę operację z prawą i lewą ścianką boczną.
Śruby 5 x 80 mm – 6 szt.



Przed połączeniem kolejnych elementów ściennych śrubami sprawdzić kąt prosty. Postępować zgodnie ze wskazówką na stronie 4.



PL

Montaż górnych elementów ściennych

Podczas montażu górnych elementów ściennych należy ponownie rozpocząć od tylnej ścianki. Zwracać uwagę na równe zakończenie z listwami połączeniowymi dolnych elementów ściennych.

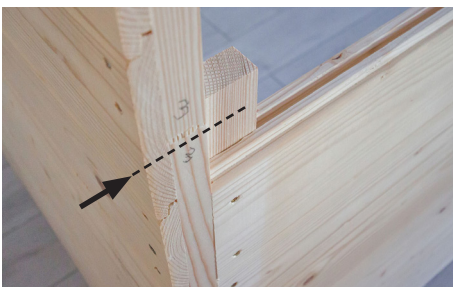

Skręcić śrubami górną ściankę tylną z obu stron z wystającą listwą dolnej ścianki tylnej. Śruby 5 x 80 mm – 2 szt.

Podczas montażu górnych elementów ściennych zwracać uwagę na równe zakończenie z listwami połączeniowymi dolnych elementów ściennych. Skręć śrubami górne elementy ścienne ze sobą, na każdy element ścienny 3 szt. śrub 5 x 80 mm.



Zwracać uwagę na to, że górny element ścienny musi być każdorazowo przykręcony do wystającej listwy dolnego elementu ściennego.

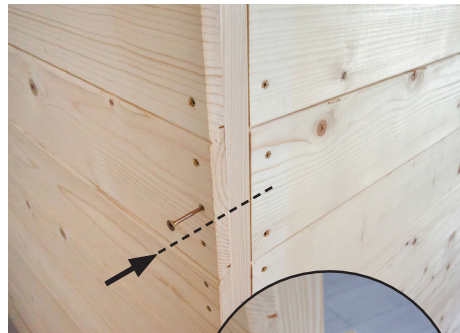
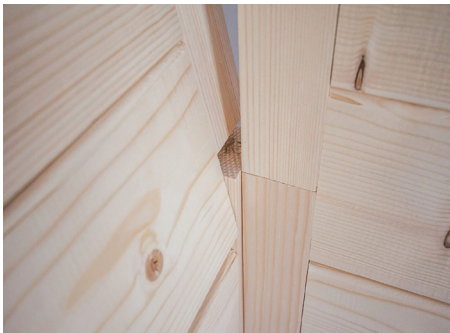



PL



Montaż drzwi

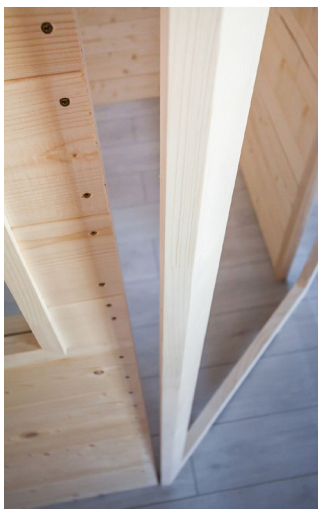

Śruby 5 x 100 mm – 6 szt.

2.2. Montaż dachu

Listwy na dachu



PL

Śruby 4 x 70 mm – 16 szt.



Elementy dachowe

Wiertło 3 mm, śruby 5 x 80 mm – 14 szt.



Wiertło 3 mm, śruby 3,5 x 40 mm – 8 szt.

PL

2.3. Montaż zasuwki do wentylacji



Wiertło 3 mm, śruby 3,5 x 40 mm – 4 szt.

2.4. Montaż urządzenia wnętrza

Listy nakładane na ławkę

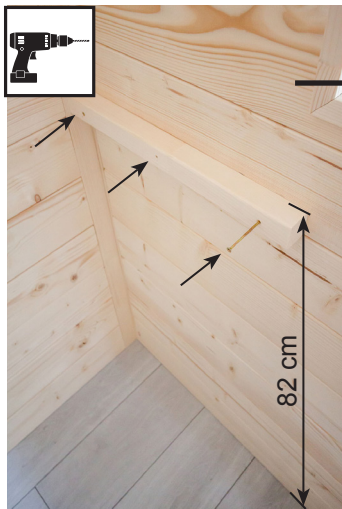

Wiertło 3 mm, śruby 5 x 70 mm – 6 szt.

Powtórzyć tę czynność po przeciwnej stronie oraz na przedniej ścianie zgodnie z poniższym rysunkiem.

Śruby 5 x 70 mm – 9 szt.

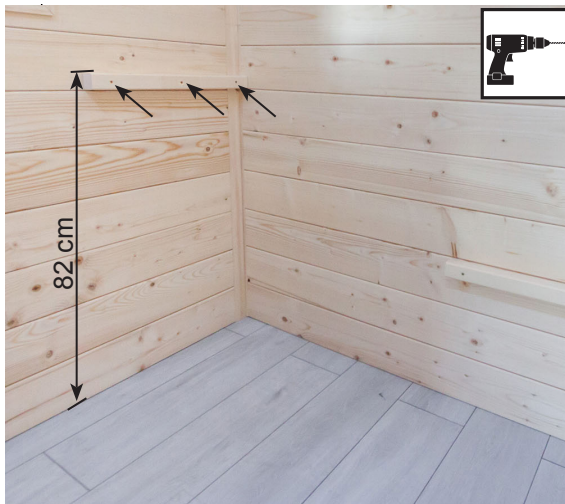
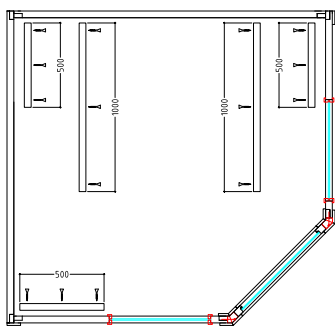

Ławka

Wiertło 3 mm, śruby 5 x 50 mm – 3 szt.



2.5. Montaż akcesoriów

Lampa do sauny



Zamontuj lampę
(nie wchodzi w zakres dostawy)



Wiertło 3 mm, śruby – 2 szt.



Śruby 3,5 x 40 mm – 4 szt.

Kratka ochronna pieca oraz listwa maskująca kable

Zamontować listwę maskującą kable oraz piec sauny przed zamocowaniem kratki ochronnej pieca na ścianie.

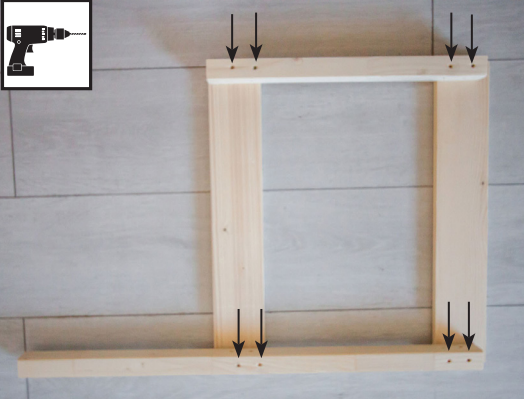

Śruby 3,5 x 40 mm – 20 szt.



Śruby 3,5 x 40 mm – 4 szt.

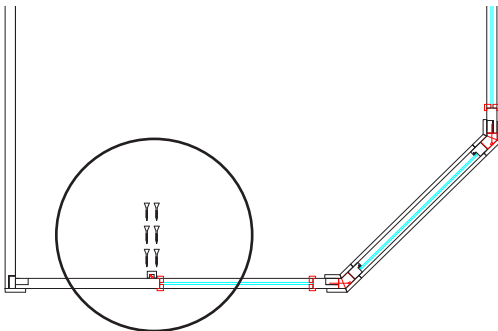

Śruby 4 x 60 mm – 6 szt.



2.6. Montaż ościeżnicy drzwi



Śruby 4 x 70 mm – 6 szt.

Uchwyt drzwiowy i blacha nakładana z góry

Zamontować blachę nakładaną od góry na wysokości otworów w drzwiach szklanych



Śruby 5 x 90 mm – 2 szt.

2.7. Montaż listew maskujących

Listwy maskujące wewnętrzne, narożne



Wiertło 3 mm, śruby 3,2 x 40 mm – 32 szt.

Listwy maskujące zewnętrzne, narożne



Wiertło 3 mm, śruby 3,2 x 40 mm – 48 szt.

Listwy maskujące drzwi, zewnętrzne i wewnętrzne

PL

Wiertło 3 mm, śruby 3,2 x 40 mm – 24 szt.

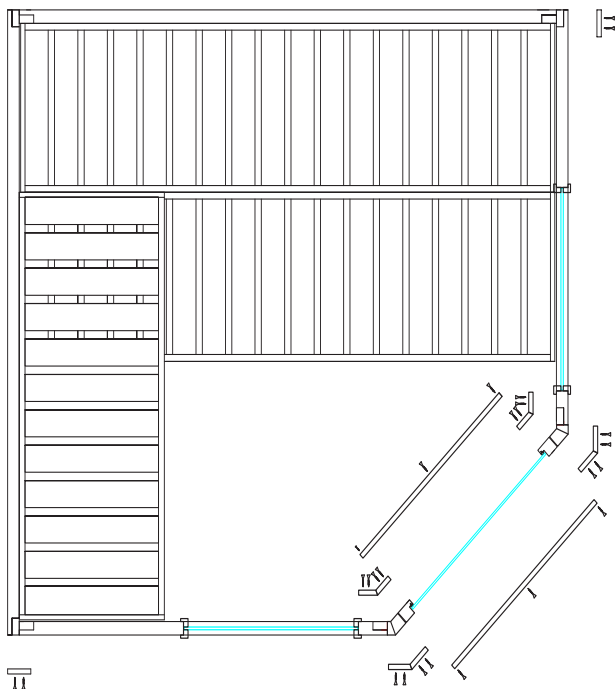

3. Rzut

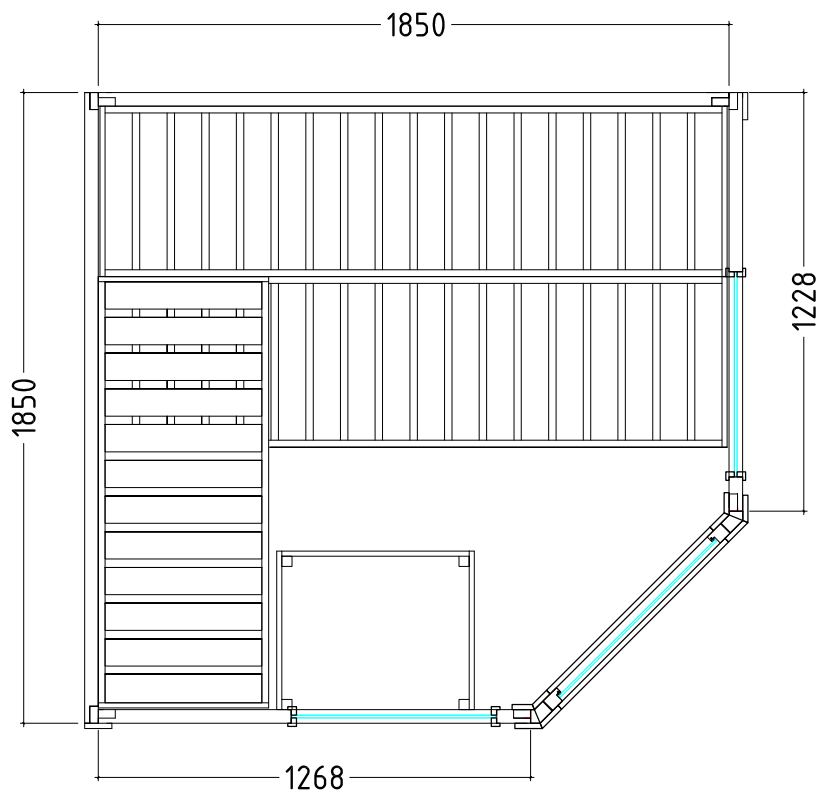



sentiotec GmbH | Division of Harvia Group | Oberregauer Straße 48, A-4844 Regau
T +43 (0) 7672/22 900-50 | F -80 | info@sentiotec.com | www.sentiotec.com